

Introduction to CBT Loudspeaker Arrays

**A Presentation Given to a Joint Meeting of the
Boston Sections of the
Audio Engineering Society,
Acoustical Society of America, and the
Boston Audio Society.**

January 14, 2010

By

Don Keele

Introduction to CBT Loudspeaker Arrays

D. B. (Don) Keele, Jr.

DBK Associates and Labs
Bloomington, IN 47408

DKeeleJr@Comcast.net

www.DBKeele.com

(Copyright 2010)

Feel free to interrupt me
with questions at any
time!

But Wait, Before We Start.....

**Are any of you
runner?**

Keele's A Runner Now!

- Started about two and half years ago.
- Last year I've done 28 competitive events mostly road races: 5K (3.1 mile), 4.5 mile, and 10K distances including five half marathons (13.1 miles); with a triathlon, and a 38-floor stair climb thrown in for good measure!
- Great fun!! My wife thinks I'm crazy!
- Pretty good for a guy who's 69 now!

Last year I ran a half marathon at Big Bear Lake, California. Altitude 6800 feet!

(Sept. 12, 2009)

My goal was to beat 3 hrs. I did it in 2 hrs 50 mins!



Half Marathon Route Map

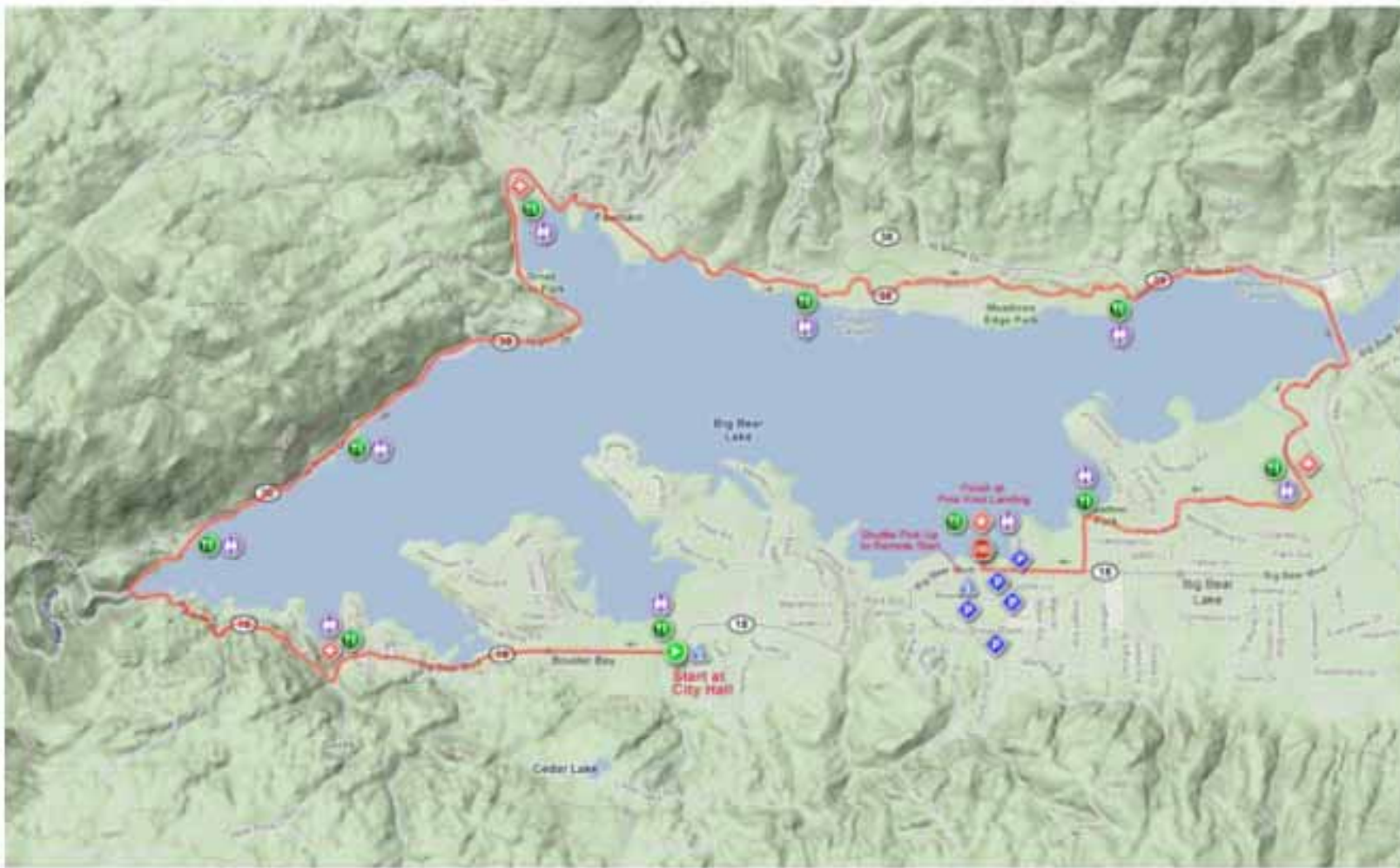

Overview Map - Half Marathon

version: 8/28/09

www.bigbearlakemarathon.com (888) 906-9955

- Feed Zone
- Medical Aid
- Bathroom
- Parking
- Start
- Finish
- Half Marathon Shuttle Stop

Run the Bear
Big Bear Lake Marathon

Took Lots of Pictures Along the Way!



1/14/2010

Keele - CBT Boston Presentation

8

And now back to our regularly
scheduled presentation.....

Broadband Constant Directivity

It's Magic!

D. B. (Don) Keele, Jr.

DBK Associates and Labs
Bloomington, IN 47408

DKeeleJr@Comcast.net

www.DBKeele.com

(Copyright 2010)

Is This Broadband Constant Directivity?



Is This Broadband Constant Directivity?



Nope!

Is This Broadband Constant Directivity?



Is This Broadband Constant Directivity?



Nope!

Is This Broadband Constant Directivity?



Is This Broadband Constant Directivity?



Nope!

Is This Broadband Constant Directivity?



Is This Broadband Constant Directivity?



Nope!

Is This Broadband Constant Directivity?



Is This Broadband Constant Directivity?



Sort of!

In horn's range only!

Is This Broadband Constant Directivity?



Is This Speaker Broadband Constant Directivity?



Maybe,

But

Unlikely

Is This Broadband Constant Directivity?



Is This Broadband Constant Directivity?



**A Big
Nope!**

Is This Broadband Constant Directivity?

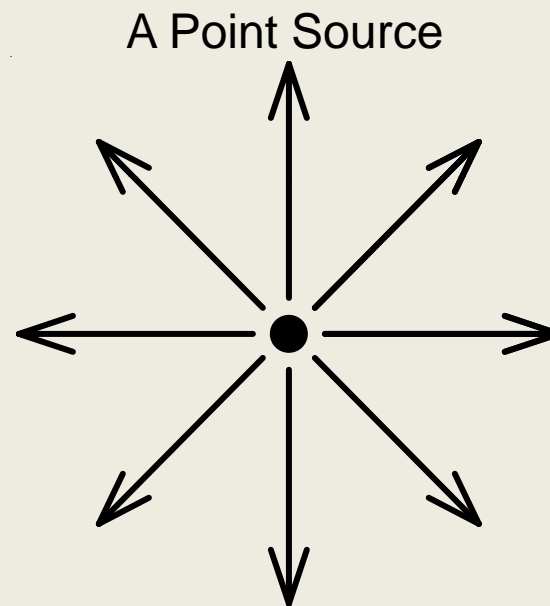

Is This Broadband Constant Directivity?

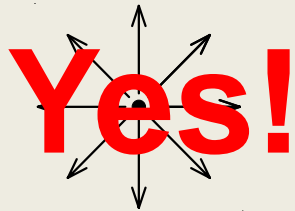

**A Big
Yep!**

Is This Broadband Constant Directivity?

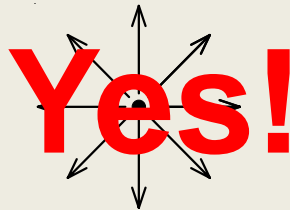

Neumann U87 Ribbon Mic.
(Figure Eight Pattern)



Is This Broadband Constant Directivity?

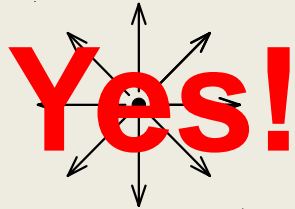

Absolutely

Yes!

(Depending on design details.)

Is This Broadband Constant Directivity?

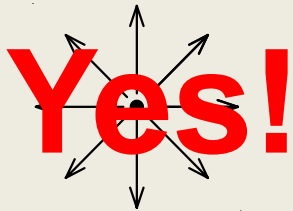

Jim Long

Don Keele

EV HR9040
"White" Horn
(Circa 1975)

Is This Broadband Constant Directivity?



Yes!



A Qualified

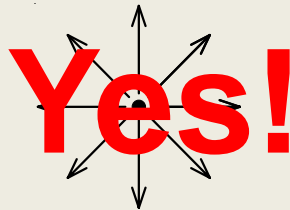

Yes!



(If the horn's big enough!)

Is This Broadband Constant Directivity?

Altec Mantaray Pro Horns (Circa 1978)

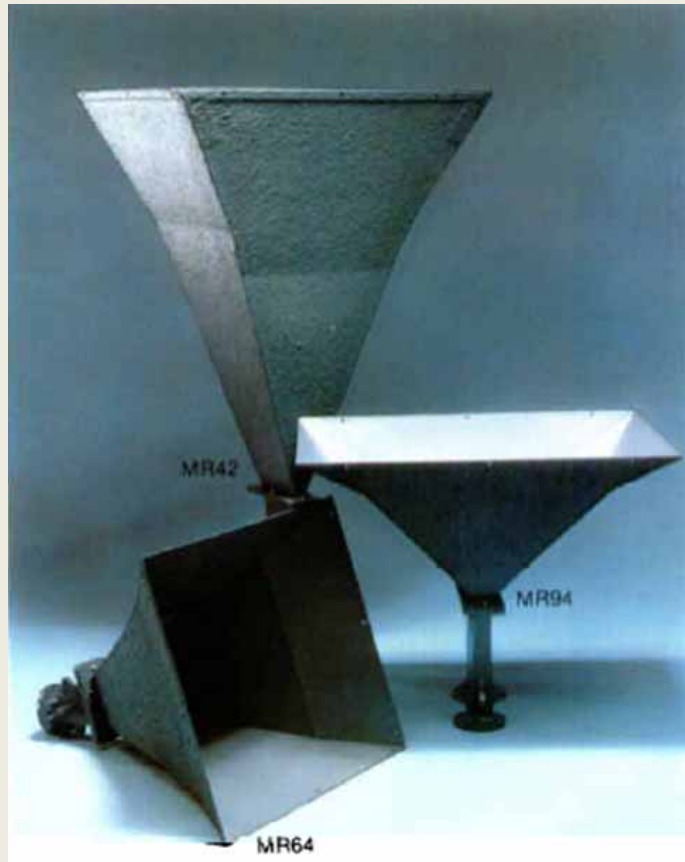

JBL Bi-Radial Pro Horns (Circa 1980)

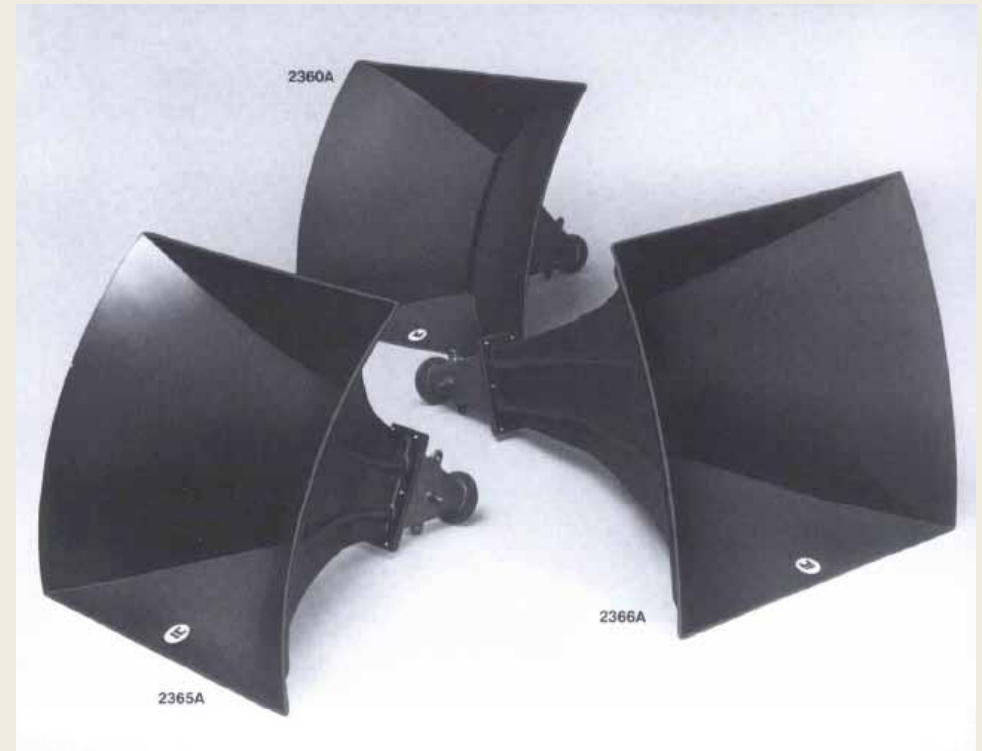

Is This Broadband Constant Directivity?



Yes!

Yes!



Yes!



Yes!

A Qualified Yes!

(If the horn's big enough!)

Is This Broadband Constant Directivity? Keele's CBT Arrays



Is This Broadband Constant Directivity?

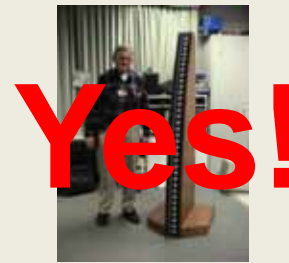
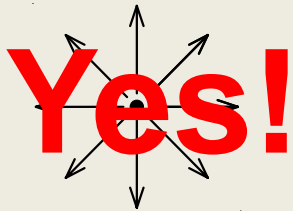

**Absolutely
Yes!**

Caution!! You are About to Enter the Keele “No Spin” Zone

(with due credit to Bill O’Reilly of Fox News)

Remember that what I am going to talk to you about this evening is the topic of two pending Harman CBT patents which will issue soon !

Pending Harman CBT Patents

US 20040240697A1

(19) **United States**
 (12) **Patent Application Publication** (10) Pub. No.: US 2004/0240697 A1
 Keele, JR. (43) Pub. Date: Dec. 2, 2004

(54) **CONSTANT-BEAMWIDTH LOUSPEAKER ARRAY** (52) U.S. Cl. 381/336; 381/335; 381/182

(76) Inventor: **D. Broadus Keele JR.**, Bloomington, IN (US) (57) **ABSTRACT**

Correspondence Address:
INDIANAPOLIS OFFICE 27879
BRINKS HOFER GILSON & LIONE
ONE INDIANA SQUARE, SUITE 1600
INDIANAPOLIS, IN 46204-2033 (US)

(21) Appl. No.: **10/701,256**
 (22) Filed: **Nov. 4, 2003**

Related U.S. Application Data

(60) Provisional application No. 60/473,513, filed on May 27, 2003.

Publication Classification

(51) Int. Cl.⁷ **H04R 25/00**; H04R 1/02

A loudspeaker is provided for receiving an incoming electrical signal and transmitting an acoustical signal that is directional and has a substantially constant beamwidth over a wide frequency range. The loudspeaker may include a curved mounting plate that has curvature over a range of angles. The loudspeaker may include an array of speaker drivers coupled to the mounting plate. Each speaker driver may be driven by an electrical signal having a respective amplitude that is a function of the speaker driver's respective location on the mounting plate. The function may be a Legendre function. Alternatively, the loudspeaker may include a flat mounting plate. In this case, the respective electrical signal driving each speaker may have a phase delay that virtually positions the speaker onto a curved surface.

1/14/2010

US 20060153407A1

(19) **United States**
 (12) **Patent Application Publication** (10) Pub. No.: US 2006/0153407 A1
 Keele, JR. et al. (43) Pub. Date: Jul. 13, 2006

(54) **REFLECTIVE LOUSPEAKER ARRAY** (52) U.S. Cl. 381/182

(76) Inventors: **D. Broadus Keele JR.**, Bloomington, IN (US); **Douglas J. Button**, Simi Valley, CA (US) (57) **ABSTRACT**

Correspondence Address:
INDIANAPOLIS OFFICE 27879
BRINKS HOFER GILSON & LIONE
ONE INDIANA SQUARE, SUITE 1600
INDIANAPOLIS, IN 46204-2033 (US)

(21) Appl. No.: **11/371,538**
 (22) Filed: **Mar. 8, 2006**

Related U.S. Application Data

(63) Continuation-in-part of application No. 10/701,256, filed on Nov. 4, 2003.
 (60) Provisional application No. 60/659,673, filed on Mar. 8, 2005. Provisional application No. 60/473,513, filed on May 27, 2003.

Publication Classification

(51) Int. Cl.
H04R 25/00 (2006.01)
 (52) U.S. Cl. 381/182

A reflective loudspeaker array is cooperatively operable with an acoustically reflective planar surface to provide a constructive combination of direct and reflected sound waves that produces a uniform sound field. The uniform sound field provides a controlled sound field in the vertical and horizontal direction, and also provides uniformity from distances close to the reflective loudspeaker array to far way. The direct and reflected sound waves are advantageously and constructively combinable to generate a focused beamwidth of soundwaves. The reflective loudspeaker array includes a plurality of loudspeakers coupled to a surface of the reflective loudspeaker array. The surface may be formed to include at least one curve with a radius of curvature. The reflective loudspeaker array may be placed adjacent an acoustically reflective planar surface such that a frontal plane of a loudspeaker adjacently located closest to the acoustically reflective planar surface is aligned perpendicularly, and a frontal plane of a loudspeaker spaced away from the acoustically reflective planar surface is not aligned perpendicularly.

Keele - CBT Boston Presentation

36

Military Prior Art

- CBTs first formulated in JASA papers published in 1978 and 1983 describing underwater transducers based on shaded spherical caps.
 - [1] W. J. Trott, “Design Theory for a Constant-Beamwidth Transducer,” Naval Research Laboratory Report 7933 (1975 Sept.)
 - [2] P. H. Rogers, and A. L. Van Buren, “New Approach to a Constant Beamwidth Transducer,” *J. Acous. Soc. Am.*, vol. 64, no. 1, pp. 38-43 (1978 July).
 - [3] J. Jarzynski, and W. J. Trott, “Array Shading for a Broadband Constant Directivity Transducers,” *J. Acous. Soc. Am.*, vol. 64, no. 5, pp. 1266-1269 (1978 Nov.).
 - [4] A. L. Van Buren, L. D. Luker, M. D. Jevnager, and A. C. Tims, “Experimental Constant Beamwidth Transducer,” *J. Acous. Soc. Am.*, vol. 73, no. 6, pp. 2200-2209 (1983 June).

Quote from Introduction:
 “It would, therefore, be desirable to have a broadband directional transducer whose beam pattern is essentially independent of frequency over its bandwidth. With such a “constant beamwidth transducer” (CBT) the spectral content of the acoustic signal would be independent of bearing.”

New approach to a constant beamwidth transducer

Peter H. Rogers and A. L. Van Buren

Naval Research Laboratory, Underwater Sound Reference Division, Orlando, Florida 32856
 (Received 29 June 1977; revised 14 December 1977)

The theory of a broadband constant beamwidth transducer which is to be used primarily as a projector is presented. The transducer is a spherical cap of arbitrary half angle α shaded so that the normal velocity is equal to $U_0 P_n(\cos \theta)$, where P_n is the Legendre function whose root of smallest angle occurs at $\theta = \alpha$. The required value for ν , the order of the Legendre function (which is not, in general, an integer) can be obtained to within 1% for $\alpha \leq 1$ radian from the approximation $\nu \approx 0.5[(4.81/\alpha) - 1]$. The transducer is shown to have uniform acoustic loading, extremely low sidelobes, and an essentially constant beam pattern for all frequencies above a certain cutoff frequency. Under piezoelectric drive the transducer is shown to have a flat transmitting current response over a broad band.

PACS numbers: 43.88.Ar, 43.20.Rz, 43.30.Jx, 43.30.Yj

INTRODUCTION

Most directional acoustic transducers and arrays exhibit beam patterns which are frequency dependent. (For example, the beamwidth of a plane piston or line array decreases with increasing frequency.) As a result, the spectral content of the transmitted (or received) signal will vary with position in the beam, and thus the fidelity of an underwater acoustic system will depend on the relative orientation of the transmitter and receiver. It would, therefore, be desirable to have a broadband directional transducer whose beam pattern is essentially independent of frequency over its bandwidth. With such a “constant beamwidth transducer” (CBT) the spectral content of the acoustic signal would be independent of bearing. A number of authors¹⁻⁶ have proposed (and built) more or less successful CBTs, but these involved the use of arrays of elements which were either interconnected by elaborate filters,¹⁻³ compensating networks,³ or delay lines^{4,5} or deployed in a complicated three-dimensional pattern,⁶ and are thus more suitable as receivers than projectors. Moreover, all of these papers concerned devices which exhibited “constant” beamwidths over a limited bandwidth. The present paper presents a simple method for obtaining a CBT that is primarily to be used as a projector and accordingly will have a flat transmitting current response over a broad (but limited) bandwidth. The constant beamwidth characteristics of this transducer, however, extend over a bandwidth which is, in theory, virtually unlimited.

There are many possible applications for such a projector.

(1) *Broadband echo ranging.* Considerably more information about a target can be ascertained if broadband signals are employed. From the shape of the returned pulse one can infer the size, shape, and construction of the target. A relatively narrow beam is desirable in order to obtain the target bearing, avoid reverberation, and exclude extraneous targets. A CBT is required since the target will not always be located directly in the center of the beam.

(2) *High-data-rate communication.* High-data-rate underwater communication requires a broad bandwidth carrier. If for reasons of security or power limitation

a directional sound beam is used, a constant beamwidth transducer is necessary to avoid loss of information due to misalignment of the transmitter and receiver. Good alignment may be difficult to achieve if the information is to be exchanged between two platforms, one or both of which may be in motion.

(3) *Broadband ultrasonic transducers for nondestructive testing, medical diagnosis, and materials research.* The fidelity of the transmitted and received signals affects the accuracy of derived parameters from flaws, tissue, and materials. The constant beam characteristics hold for the nearfield as well as for the farfield, thus making the application to highly directive ultrasonic transducers possible.

I. THEORY

It is well known⁷⁻⁹ that if the radial velocity on the surface of a rigid sphere of radius a is equal to $U_0 g(\theta) \times e^{-i\omega t}$, where ω is the angular frequency, then the corresponding acoustic pressure will be

$$p(R, \theta, t) = i\rho c U_0 e^{-i\omega t} \sum_{n=0}^{\infty} A_n P_n(\cos \theta) \frac{h_n'(kR)}{h_n'(ka)}, \quad (1)$$

where R and θ are spherical coordinates, h_n is a spherical Hankel function, h_n' is its derivative, ρ is the density and c the sound speed of the surrounding fluid, and $k = \omega/c$ is the wave number. The quantity U_0 is the peak velocity, and $u(\theta)$ is the dimensionless velocity distribution. The quantities A_n are the coefficients in the expansion of $u(\theta)$ in the following series of Legendre polynomials $P_n(\cos \theta)$,

$$u(\theta) = \sum_{n=0}^{\infty} A_n P_n(\cos \theta), \quad (2)$$

and are defined by

$$A_n = (n + \frac{1}{2}) \int_0^\pi u(\theta) P_n(\cos \theta) \sin \theta d\theta. \quad (3)$$

The farfield pressure, defined as the limit of $p(R, \theta, t)$ when $R \rightarrow \infty$, is written as

$$p_{FF}(R, \theta, t) = (\rho c U_0 a e^{ik(R-a)}/R) e^{-i\omega t} g(\theta), \quad (4)$$

where the angular dependence (beam pattern) $g(\theta)$ is given by

Keele CBT References

- Keele Five AES CBT Papers (2000-2005):
 - [1] D. B. Keele, Jr., “The Application of Broadband Constant Beamwidth Transducer (CBT) Theory to Loudspeaker Arrays,” 109th Convention of the Audio Engineering Society, Preprint 5216 (Sept. 2000).
 - [2] D. B. Keele, Jr., “Implementation of Straight-Line and Flat-Panel Constant Beamwidth Transducer (CBT) Loudspeaker Arrays Using Signal Delays,” 113th Convention of the Audio Engineering Society, Preprint 5653 (Oct. 2002).
 - [3] D. B. Keele, Jr., “Full-Sphere Sound Field of Constant Beamwidth Transducer (CBT) Loudspeaker Line Arrays,” J. Audio Eng. Soc., vol. 51, no. 7/8 (July/August 2003).
 - [4] D. B. Keele, Jr., “Practical Implementation of Constant Beamwidth Transducer (CBT) Loudspeaker Circular-Arc Line Arrays,” 115th Convention of the Audio Engineering Society, Preprint 5863 (Oct. 2003).
 - [5] D. B. Keele, Jr. and D. J. Button, “Ground-Plane Constant Beamwidth Transducer (CBT) Loudspeaker Circular-Arc Line Arrays,” 119th Convention of the Audio Engineering Society, Preprint 6594 (Oct. 2005).

Spherical Cap Transducers

- 100° Circular Spherical Cap

Oblique View

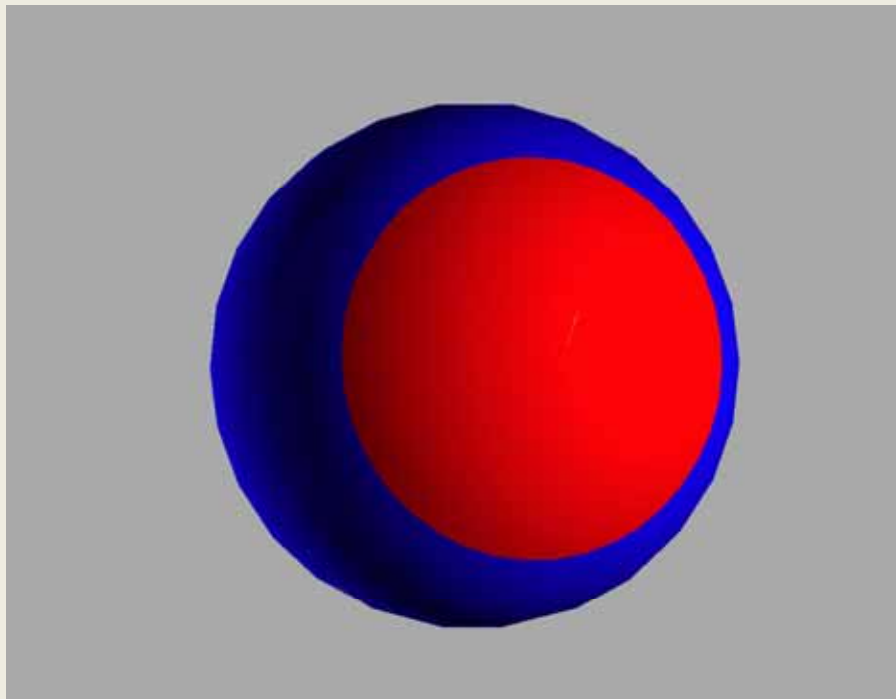

Side View

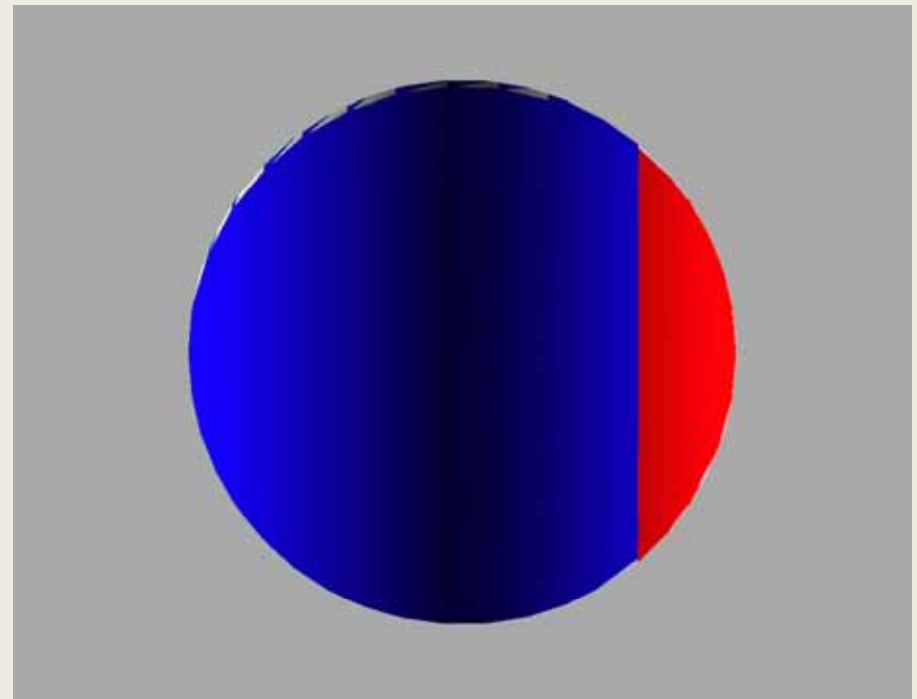

Shaded Spherical Cap

- Legendre Function Shading

$$u(\theta) = \begin{cases} P_\nu(\cos\theta) & \text{for } \theta \leq \theta_0 \\ 0 & \text{for } \theta > \theta_0 \end{cases}$$

where

$u(\theta)$ = radial velocity distribution

θ = elevation angle in spherical coordinates,

($\theta = 0$ is center of circular spherical cap)

θ_0 = half angle of spherical cap

$P_\nu(x)$ = Legendre function of order ν ($\nu > 0$) of argument x ,

Shaded Spherical Cap

- Velocity shading functions for Legendre orders of $\nu = 5, 7.5,$ and 10 . (Reproduced from Rogers and Van Buren [2]):

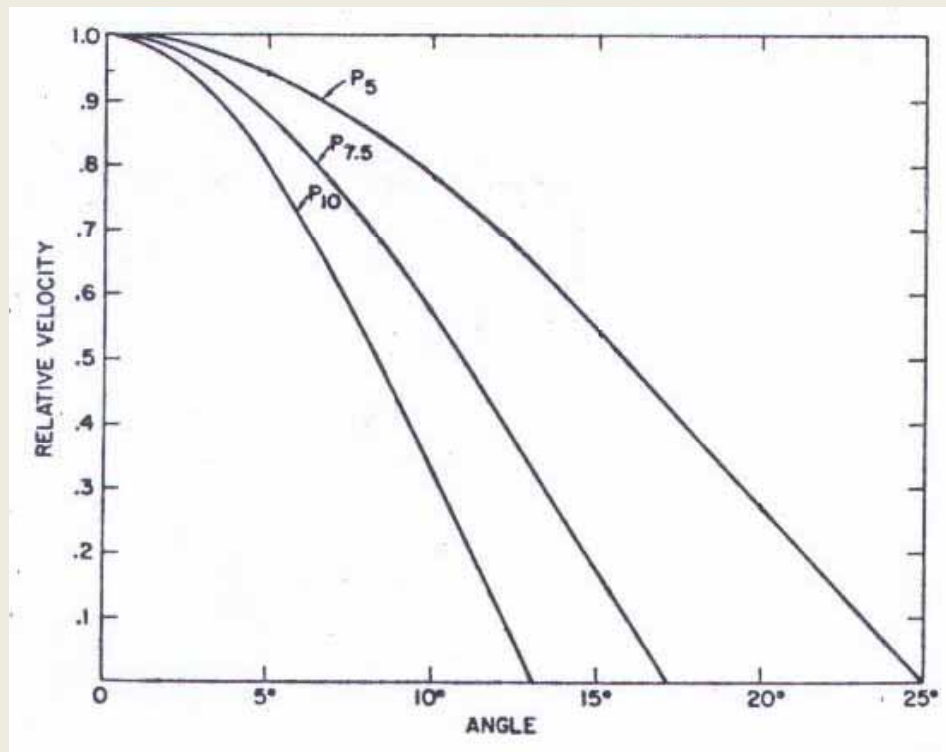

Shaded Spherical Cap

- Approximation to Farfield Pressure Pattern

$$p(\theta) = \begin{cases} P_v(\cos \theta) & \text{for } \theta \leq \theta_0 \\ 0 & \text{for } \theta > \theta_0 \end{cases}$$

where

$p(\theta)$ = radial pressure distribution.

QED: Surface pressure distribution, nearfield pressure pattern, and farfield pressure pattern are all essentially the same, i.e. no nearfield!! Polar pattern is independent of distance!!

Shaded Spherical Cap

- Power Series Approximation of Legendre Shading Function (Keele):

$$U(x) \approx \begin{cases} 1 + 0.066x - 1.8x^2 + 0.743x^3 & \text{for } x \leq 1 \\ 0 & \text{for } x > 1 \end{cases}$$

where

$$x = \text{normalized angle} \left(\frac{\theta}{\theta_0} \right)$$

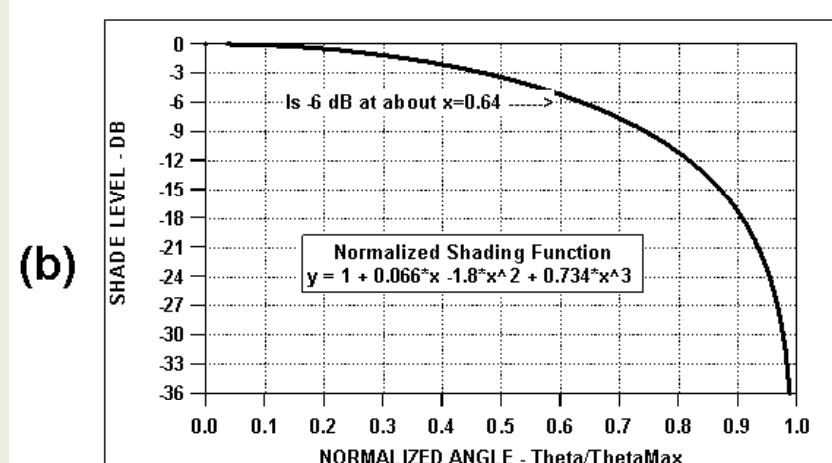
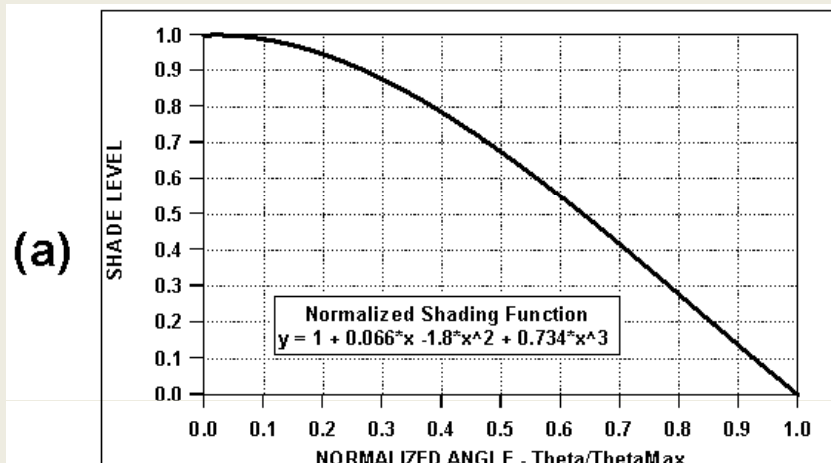

Legendre Shading

Reproduced from Van Buren [4].

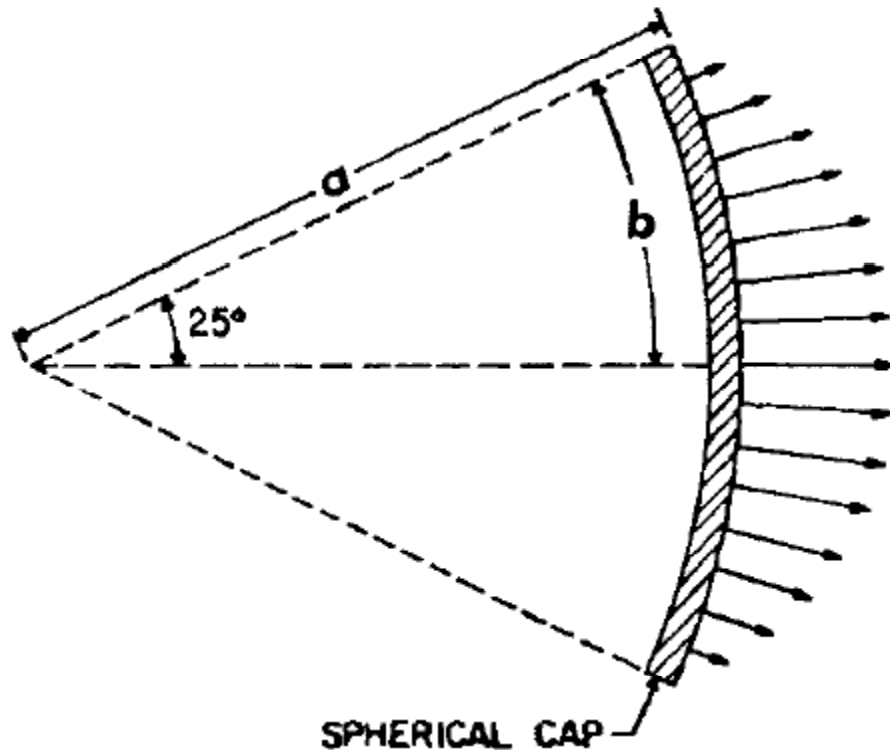

FIG. 6. Cross-sectional view of the spherical cap for a P_3 CBT. Arrows indicate the relative surface velocity distribution. The cap radius b is measured on the outer spherical surface.

Shaded Spherical Cap

- Geometry of spherical cap constant-beamwidth transducers. (Reproduced from Rogers and Van Buren [2]):

P_5 CBT 50°

$P_{7.5}$ CBT 34°

P_{10} CBT 26°

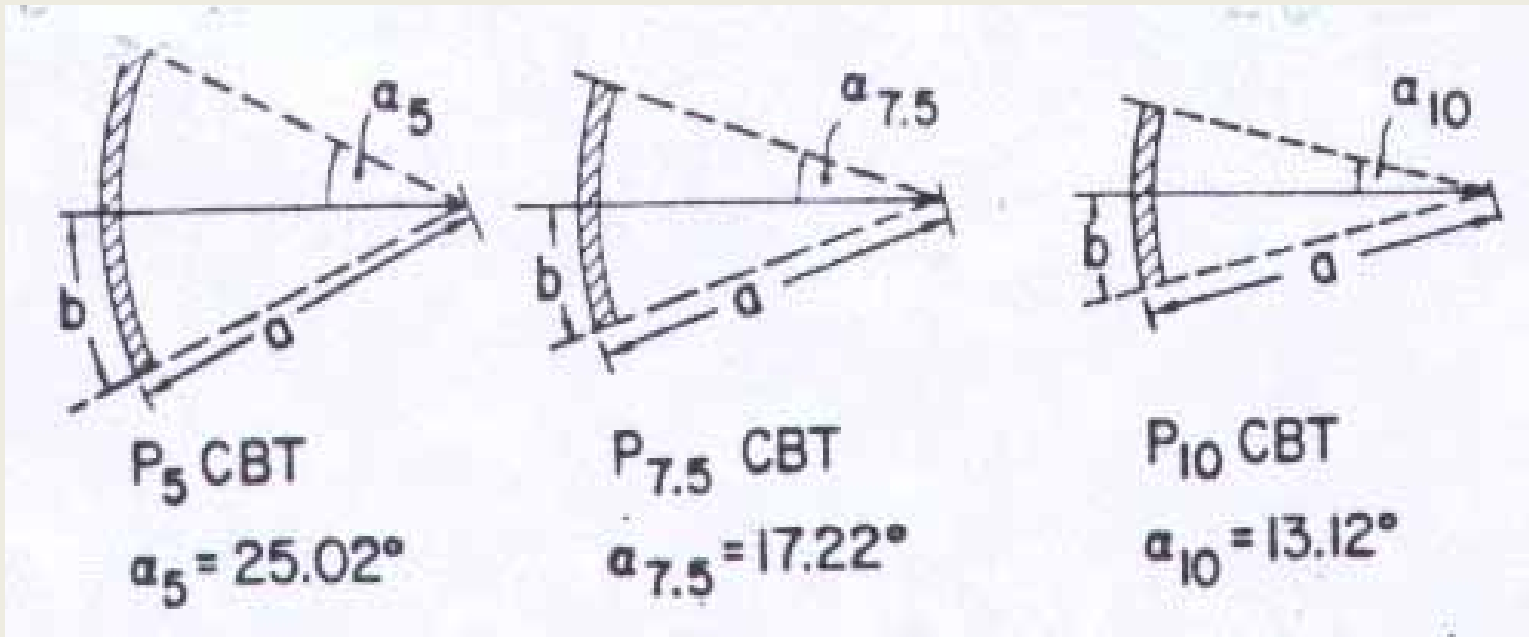

Shaded Spherical Cap

- CBT polar patterns (Reproduced from Rogers and Van Buren [2]):

P_5 CBT

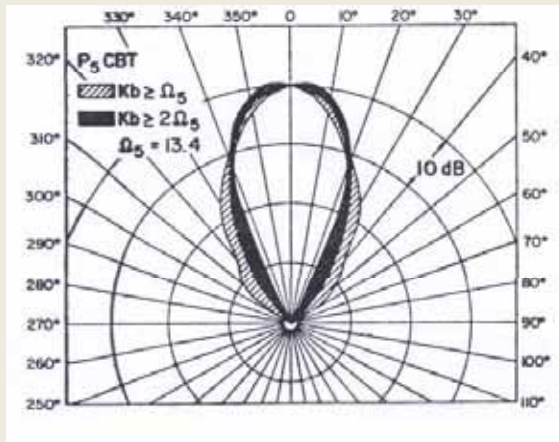

$P_{7.5}$ CBT

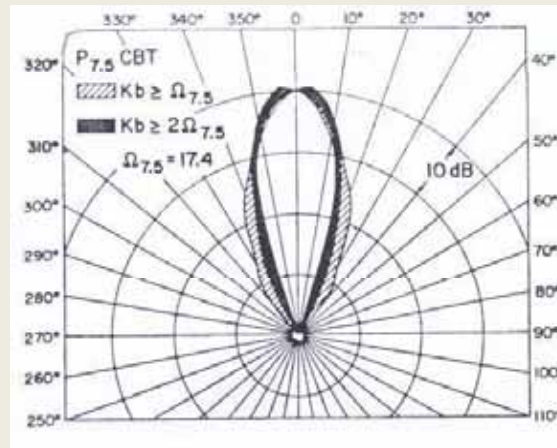

P_{10} CBT

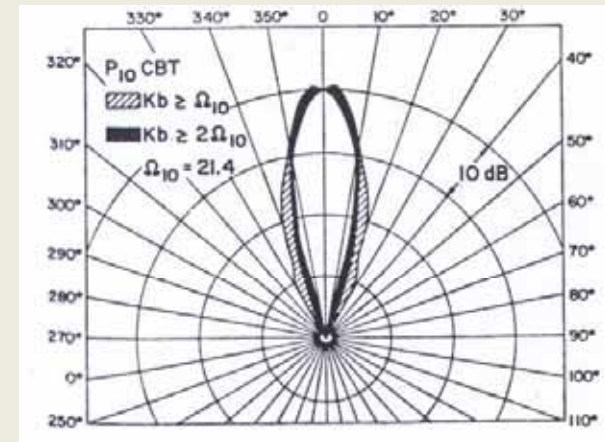

Apply CBT Theory to Loudspeaker Arrays

(From Keele 2000 [2])

Circular Spherical -Cap
Array

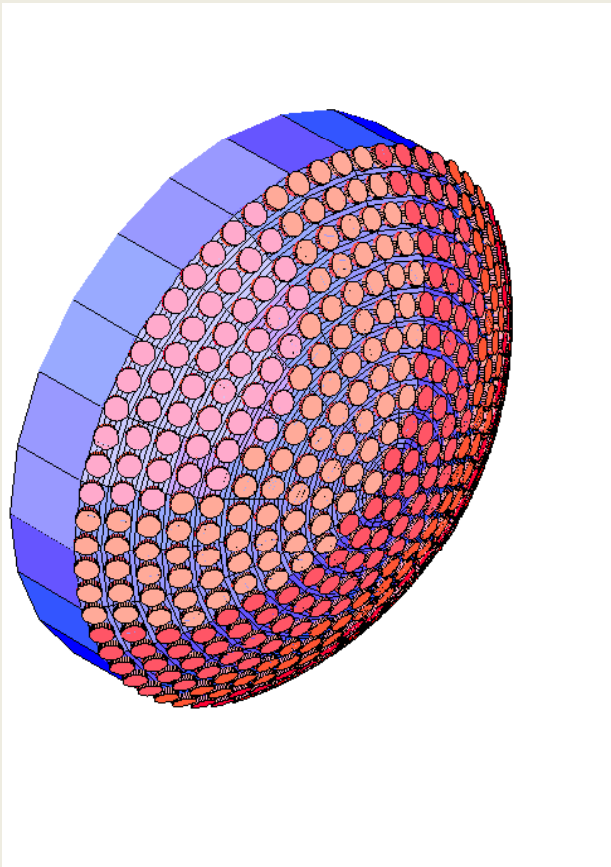

Elliptical Toriodal-Cap
Array

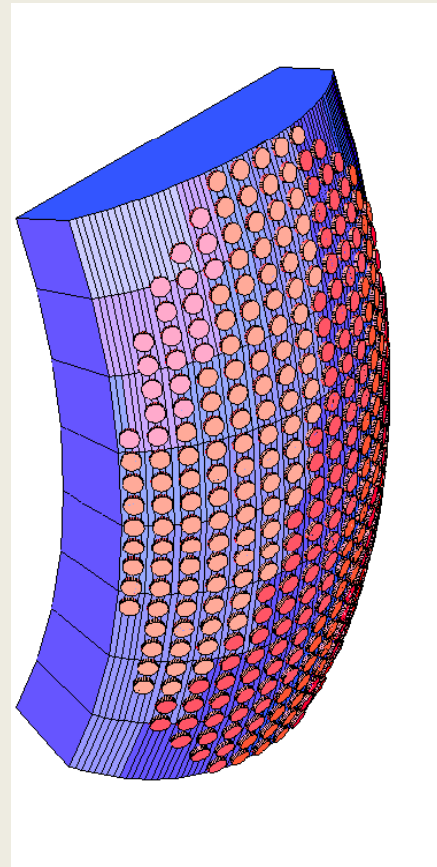

Circular-Arc Line
Array

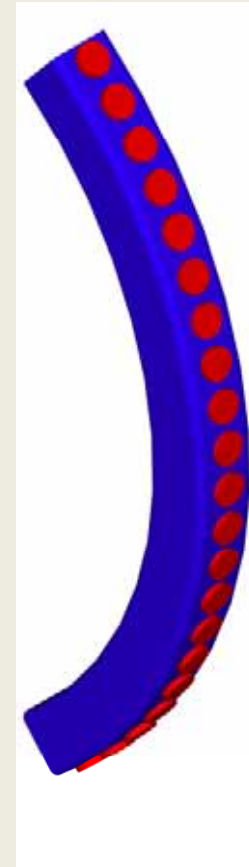

Apply CBT Theory to Loudspeaker Line Arrays

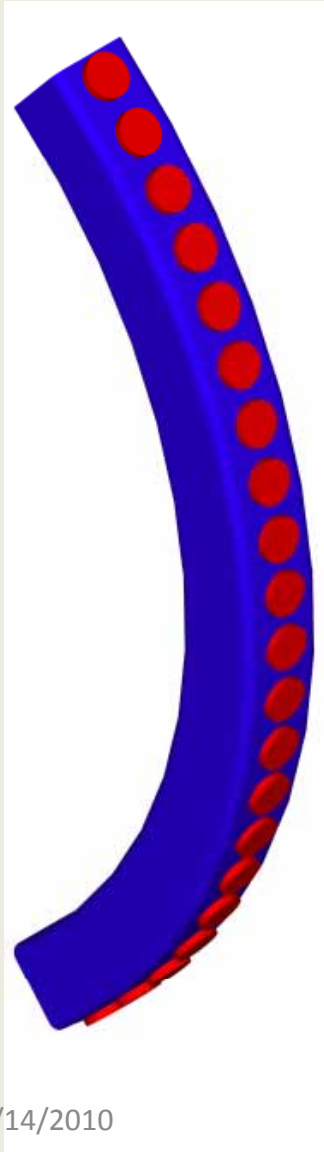

Curved Line Source:

(Arrange speakers around a circular arc and apply frequency-independent Legendre shading.)

Simulate 21 Sources around a 100° circular arc. (Height is one-wavelength high at 1 kHz).

Simulate with and without shading.

Apply CBT Theory to Loudspeaker Line Arrays

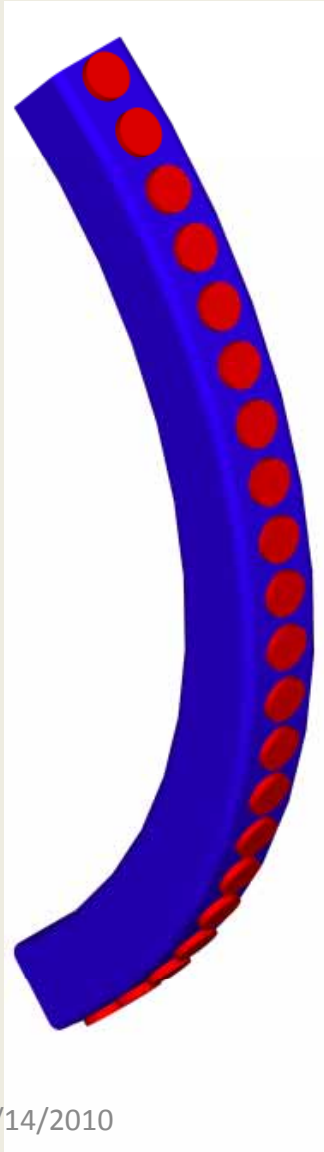

Curved Line Sources
(Arrange speakers around a circular arc and apply frequency-independent Legendre shading.)

No DSP!!
Shading can be implemented passively!!

Simulate 21 Sources around a 100° circular arc. (Height is one-wavelength high at 1 kHz).

Simulate with and without shading.

Shading

(Show Level in dB)

No Shading

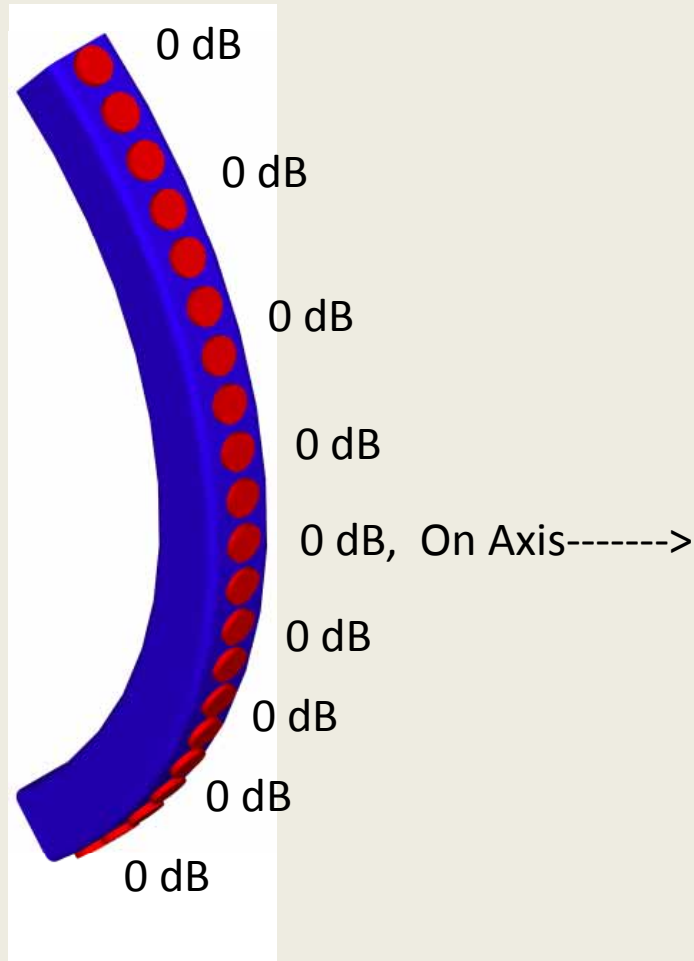

With Legendre Shading

(-12 dB Truncated and Stepped)

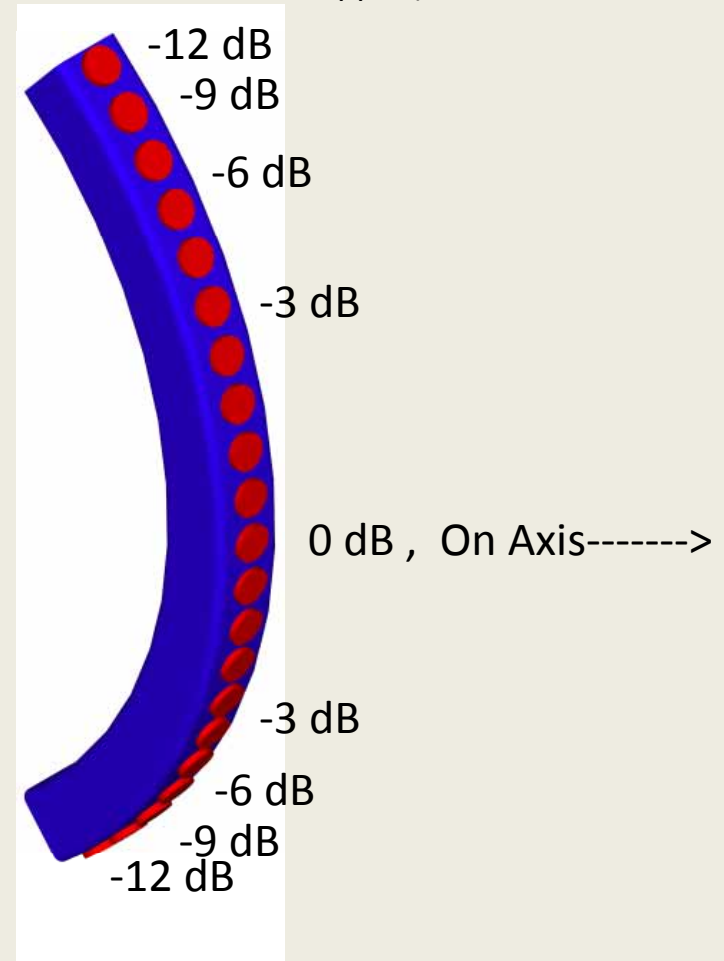

Truncated and Stepped Shading Implemented Passively

(Five Banks: 0, -3, -6, -9, -12 dB)

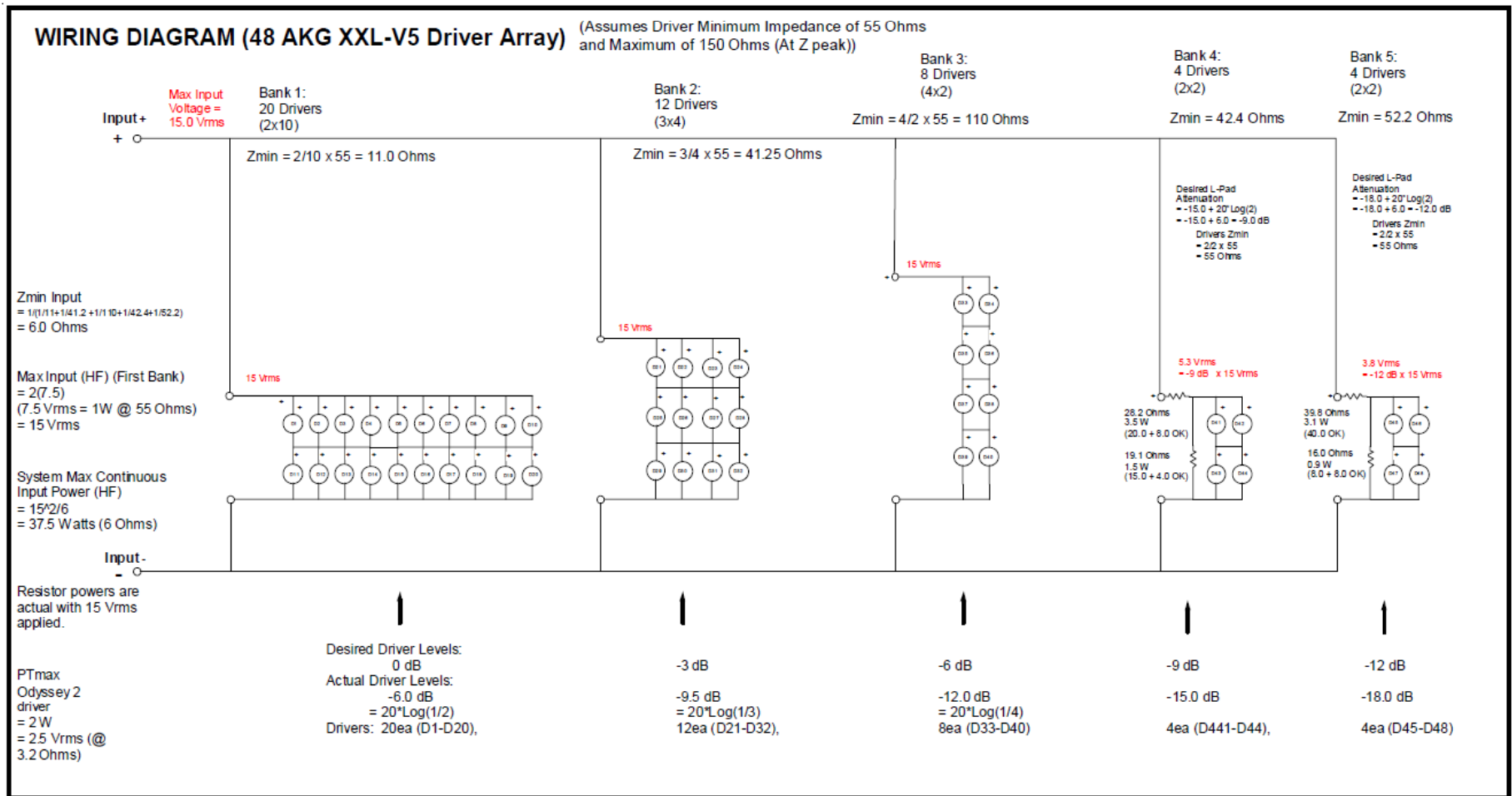

Truncated and Stepped Shading Implemented Passively

(Five Banks: 0, -3, -6, -9, -12 dB)

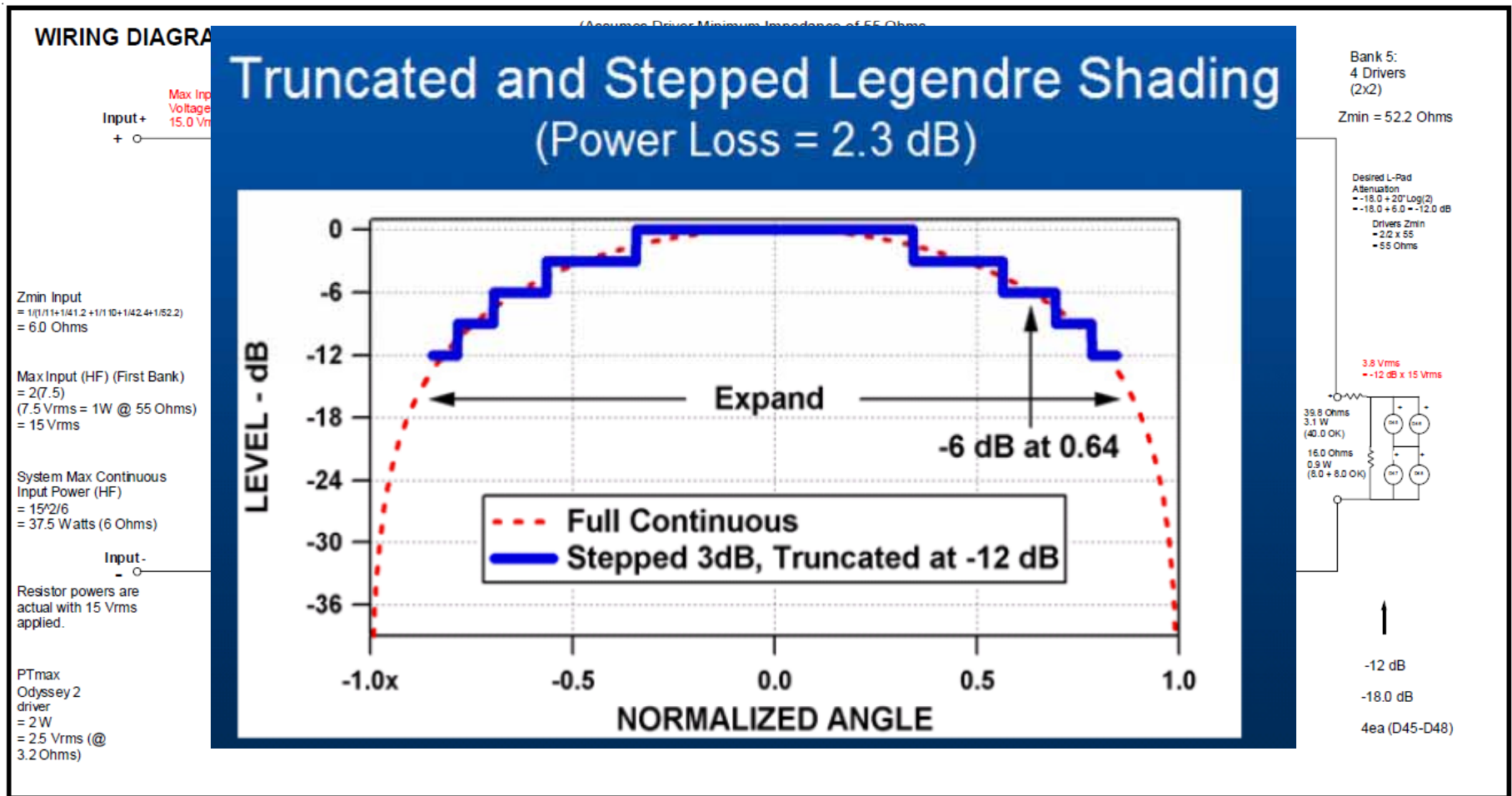

Simulation Results

- Curved Line Source (100° Circular-Arc)
 - **No Shading** (Equal drive levels)

BEAMWIDTH

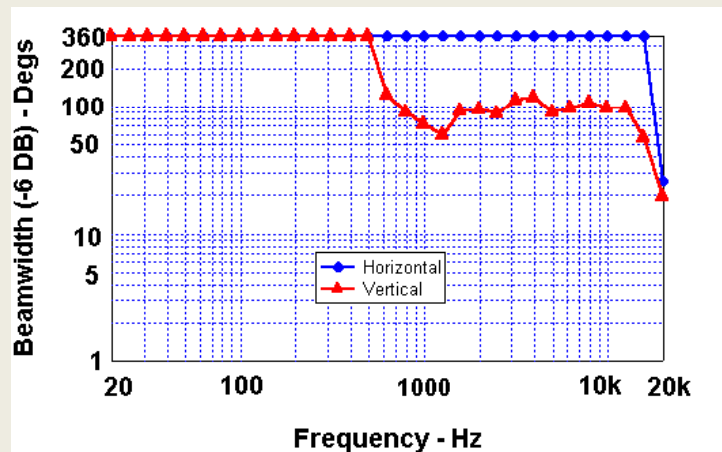

DIRECTIVITY

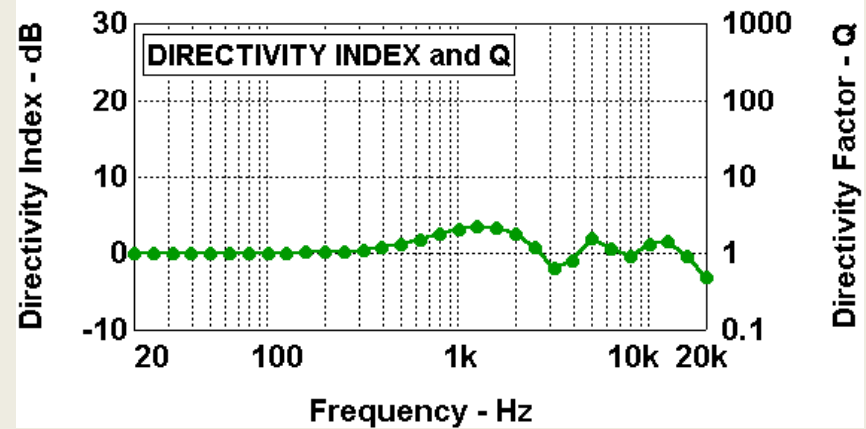

ON-AXIS LOSS

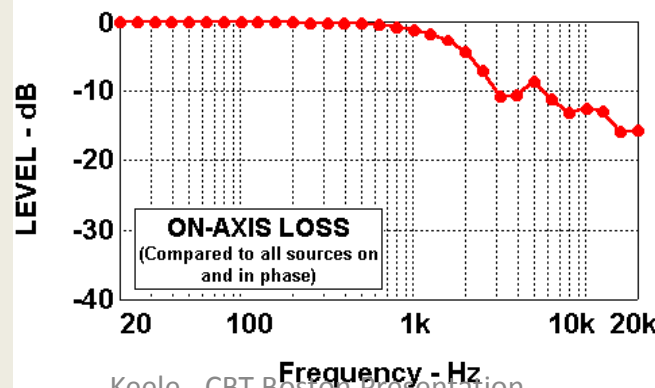

Simulation Results

- Curved Line Source (100° Circular-Arc)
 - With Full Legendre Shading

BEAMWIDTH

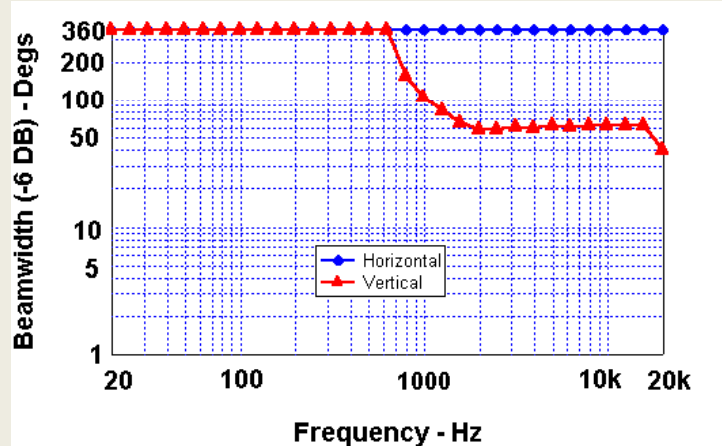

DIRECTIVITY

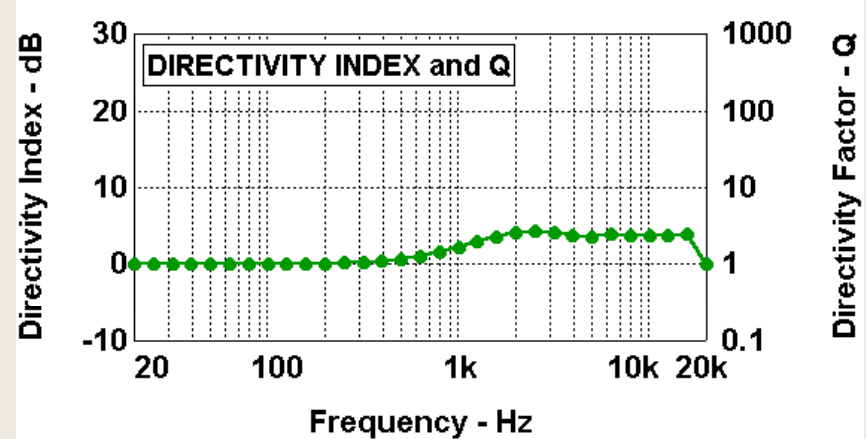

ON-AXIS LOSS

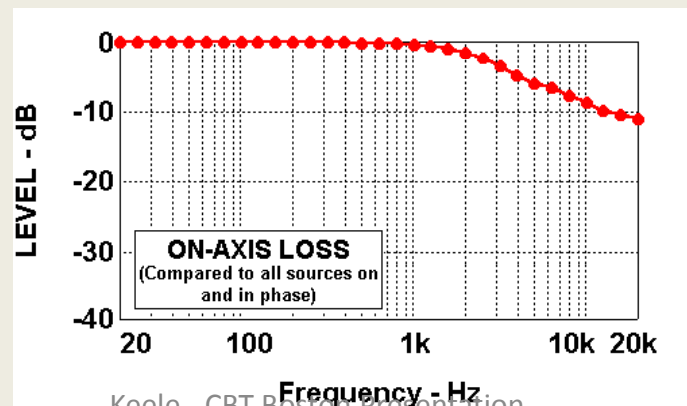

Simulation Results

- Curved Line Source (100° Circular-Arc)
 - With Full Legendre Shading

BEAMWIDTH

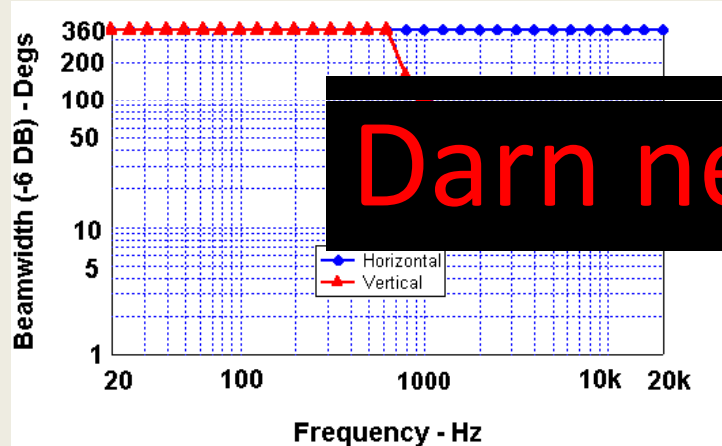

DIRECTIVITY

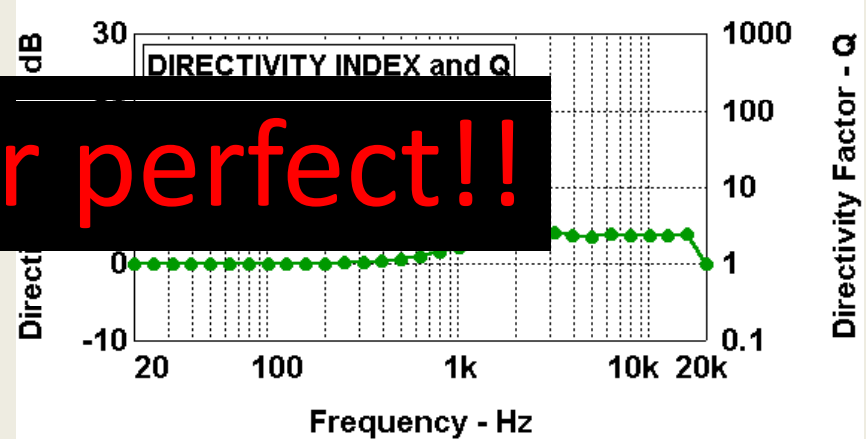

ON-AXIS LOSS

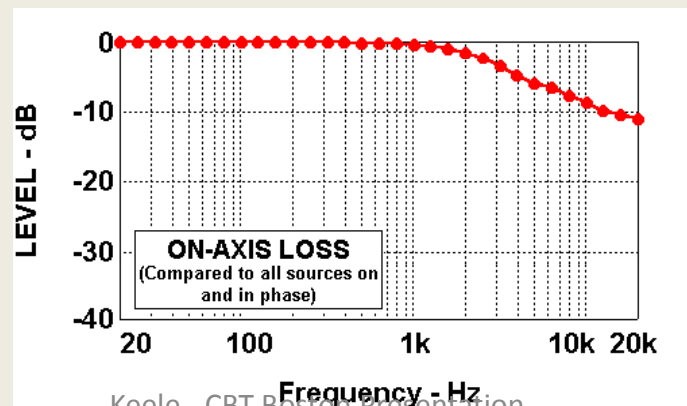

Two CBT Line-Array Versions

Free-Standing Version

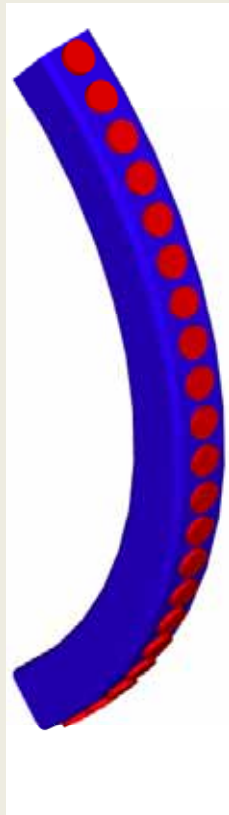

Ground-Plane Version

(Cutoff the bottom half of the array and place the bottom on a reflective surface.)

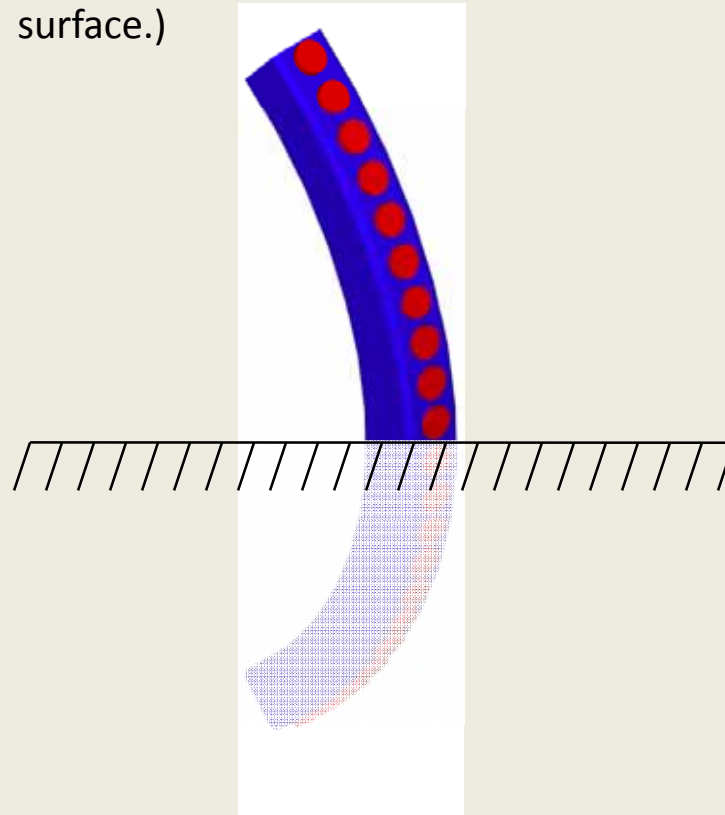

A Comparison of the Simulated Vertical-Plane Sound Field of Six Different Types of Line Arrays

- **Types of Arrays:**
 - **1. Straight-Line Array:**
 - No Shading
 - **2. Straight-Line Array:**
 - With Shading (Hann)
 - **3. Curved-Line Array:**
 - 60° Circular-Arc, No Shading (Provides a coverage angle of about 60° at high frequencies)
 - **4. CBT Curved-Line Array:**
 - 60° Circular-Arc, With Shading (Legendre) (Provides a coverage angle of about 40° at high frequencies)
 - **5. Straight-Line Array, CBT Delay-Curved:**
 - Generates a 60° Circular-Arc, With Shading (Legendre) (Provides a coverage angle of about 40° at high frequencies)
 - **6. “J” Line Array:**
 - No Shading, Straight Top Half , 60° Circular-Arc Curved Bottom Half

Six Different Types of Arrays Compared

All arrays are composed of 100 wide-band omni-directional point sources. Source center-to-center spacing is about 20mm (0.8 in). (Only 50 sources shown on each array here.)

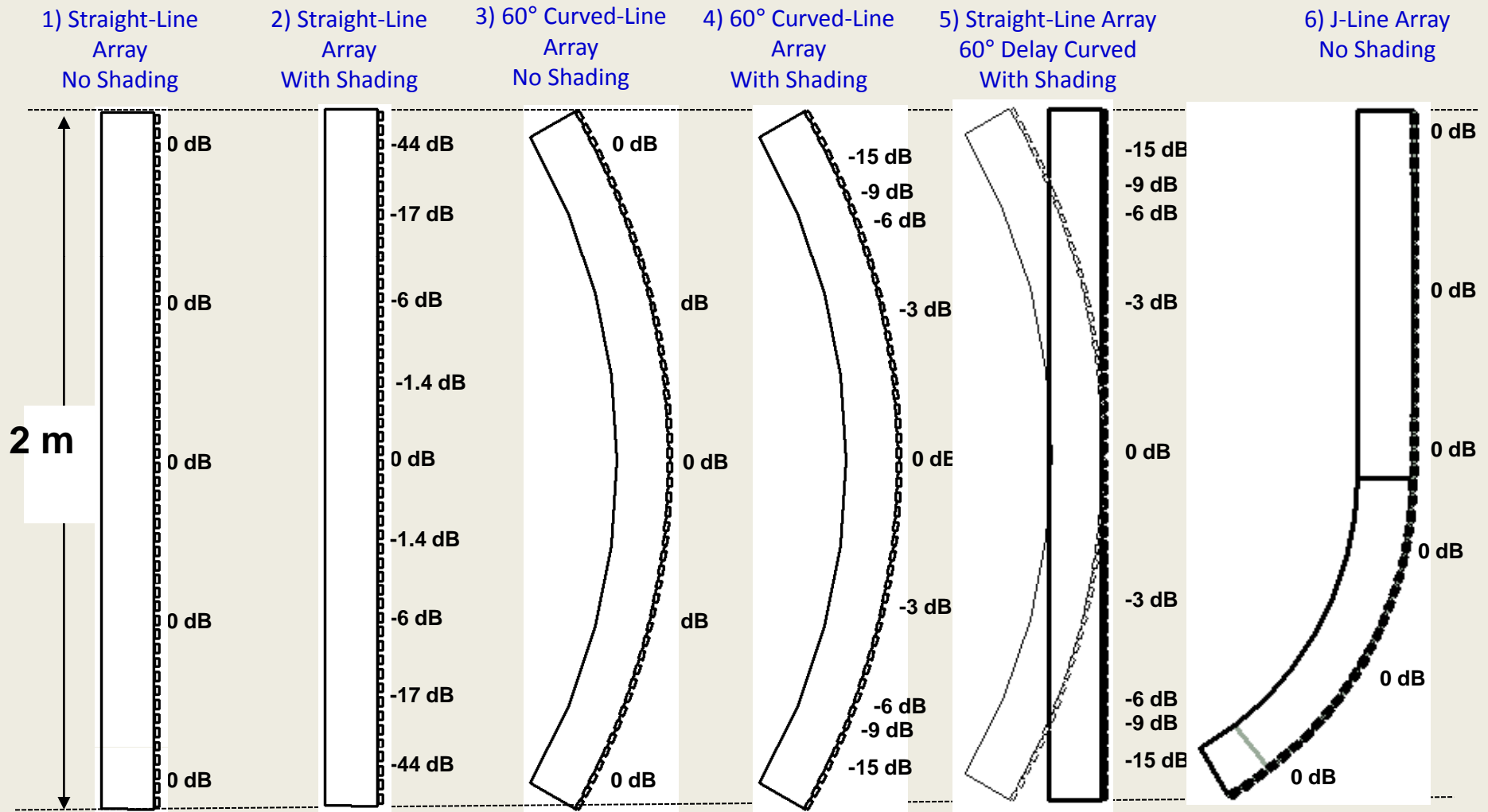

Simulation Conditions

Conditions:

- Straight-line array is located at origin. Curved-line arrays are located with center of curvature at origin.
- The vertical sound field is plotted in a region of 6 x 6 m (240 in, 20 ft) with origin on left at (0, 0).
- The soundfields are plotted at all 3rd-octave center frequencies from 50 Hz to 20 kHz.
- All arrays are equalized flat on axis at 6 m (240 in, 20 ft).
- SPL magnitude is plotted on the left and phase on the right.

Note that phase plot is only accurate up to roughly 2 kHz and exhibits visual aliasing at all higher frequencies.

Example Simulation of Straight-Line Array

STRAIGHT-LINE ARRAY, 2m HIGH, 100 SOURCES, EQUAL DRIVE LEVELS (No shading): **1 kHz**

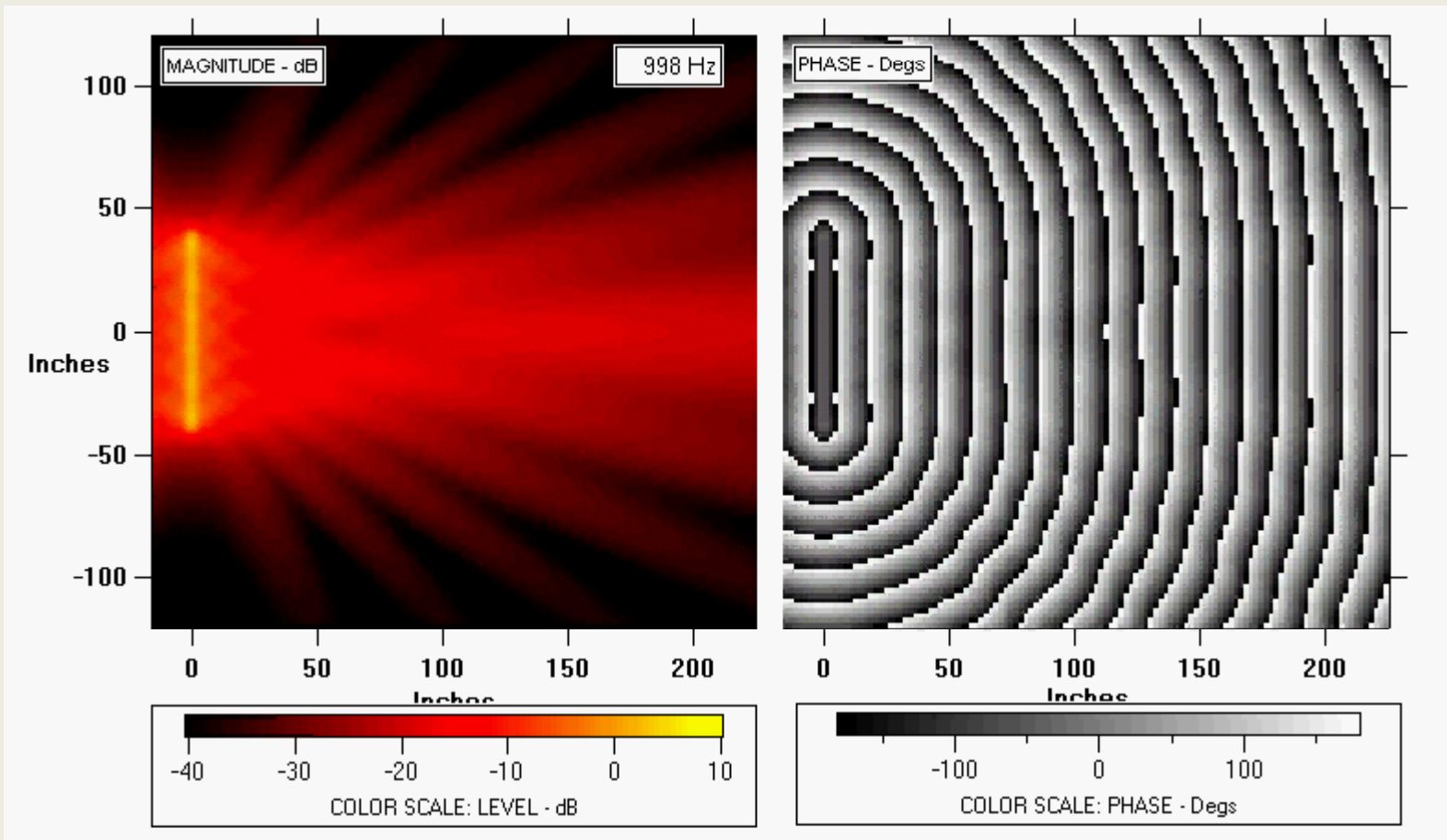

Equalized Flat On Axis

Switch to Straight-Line PPT Demo

Frequency: 1 kHz Composite Simulations

1. Straight-Line Array, No Shading

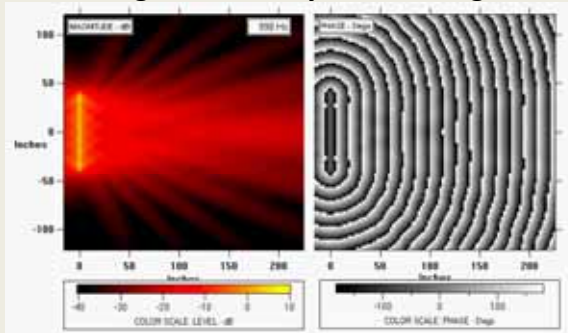

2. Straight-Line Array, With Shading

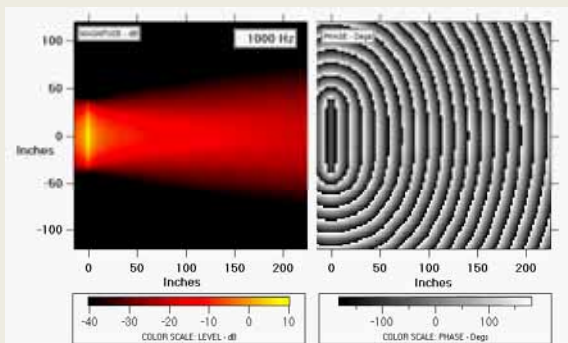

3. Curved-Line Array, No Shading

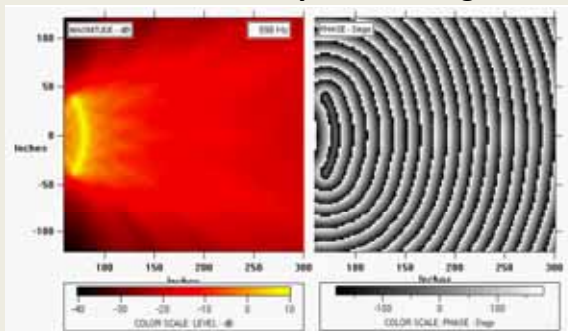

4. CBT Curved-Line Array

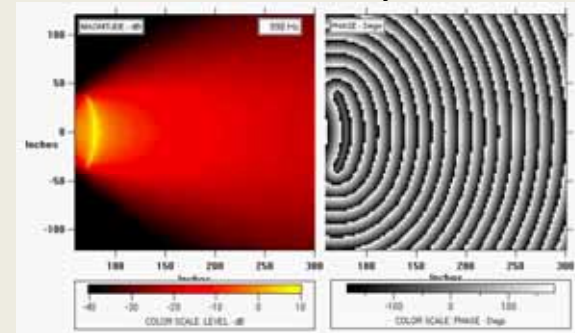

5. CBT Delay-Curved Straight-Line Array

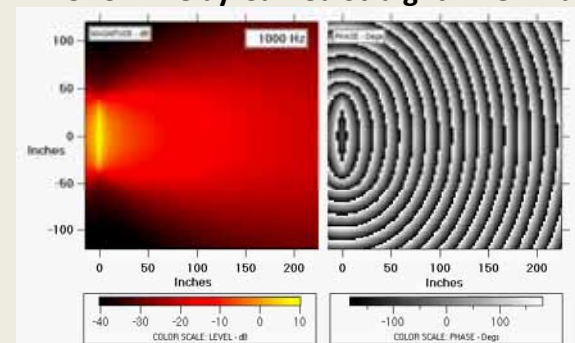

6. "J" Line Array

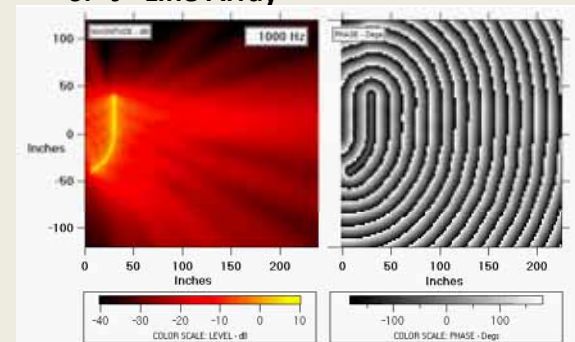

Frequency: 1 kHz Composite Simulations

1. Straight-Line Array, No Shading

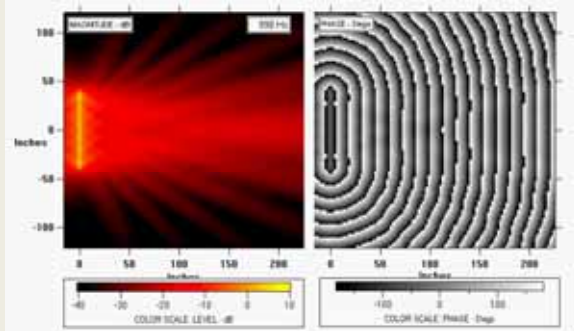

2. Straight-Line Array, With Shading

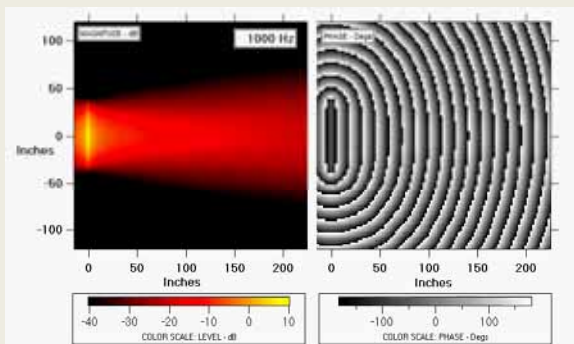

3. Curved-Line Array, No Shading

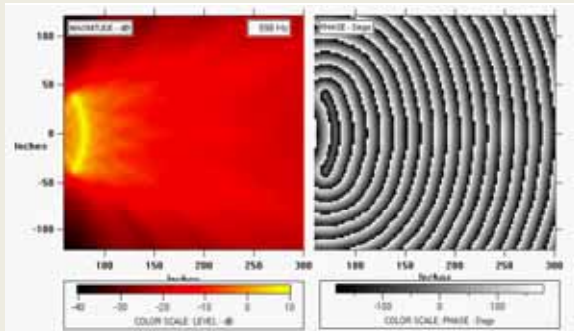

4. CBT Curved-Line Array

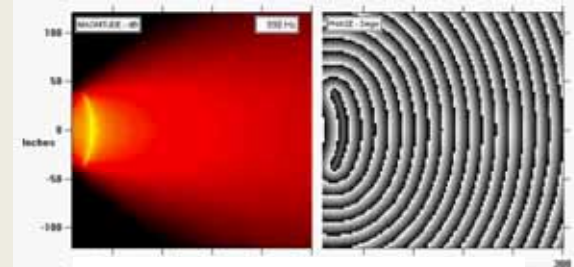

CBT Arrays

5. CBT Delay-Curved Straight-Line Array

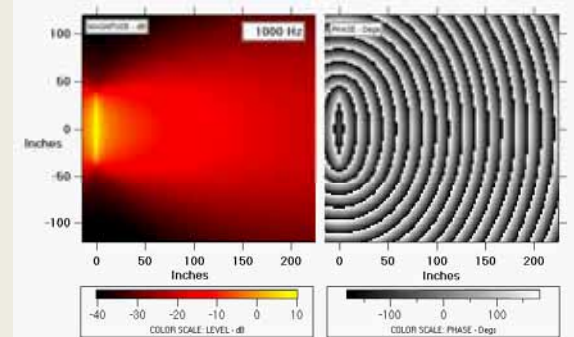

6. "J" Line Array

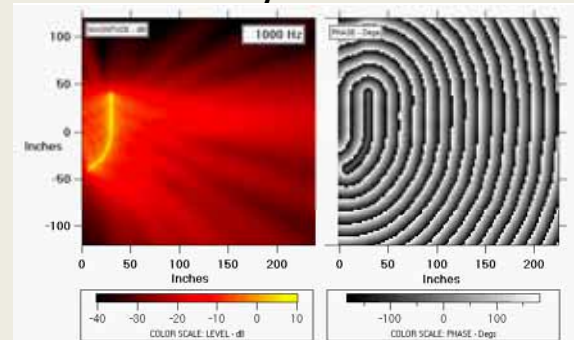

Play Composite Sound-Field Simulation PPT Movie

CBT Array Polar Pattern is Independent of Distance!

100 m Polar Map

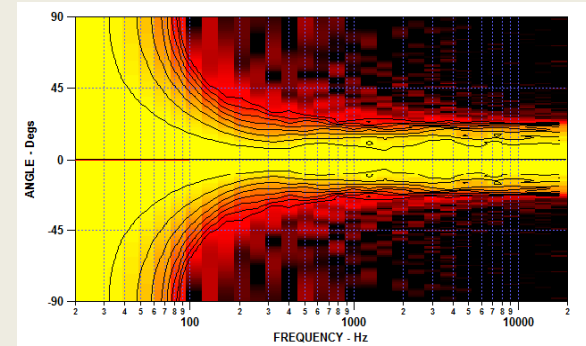

Polar Rotation:

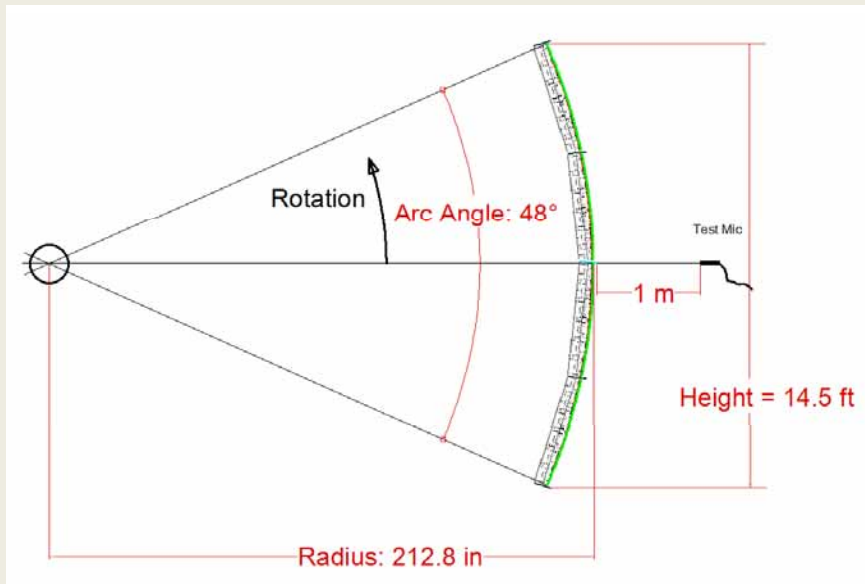

10 m Polar Map

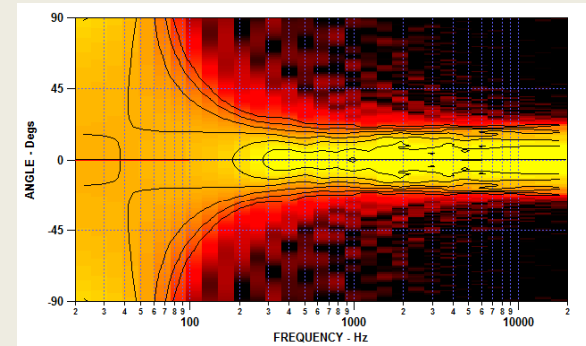

1 m Polar Map

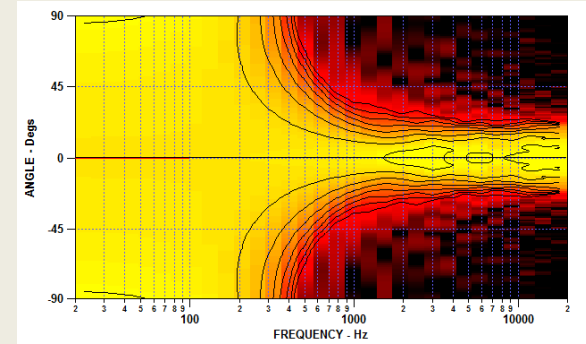

Implementation of CBT Arrays

- Angle vs. Height vs. LF Control Frequency
Tradeoffs: Show Nomographs
- Implementation using individual drivers
- Keele Prototypes
- Implementation using systems
- Marshall Kay Church System
- Monte Kay Home Theater Center Channel

FREE-STANDING CBT ARRAY: Angle vs. Height vs. LF Control Frequency

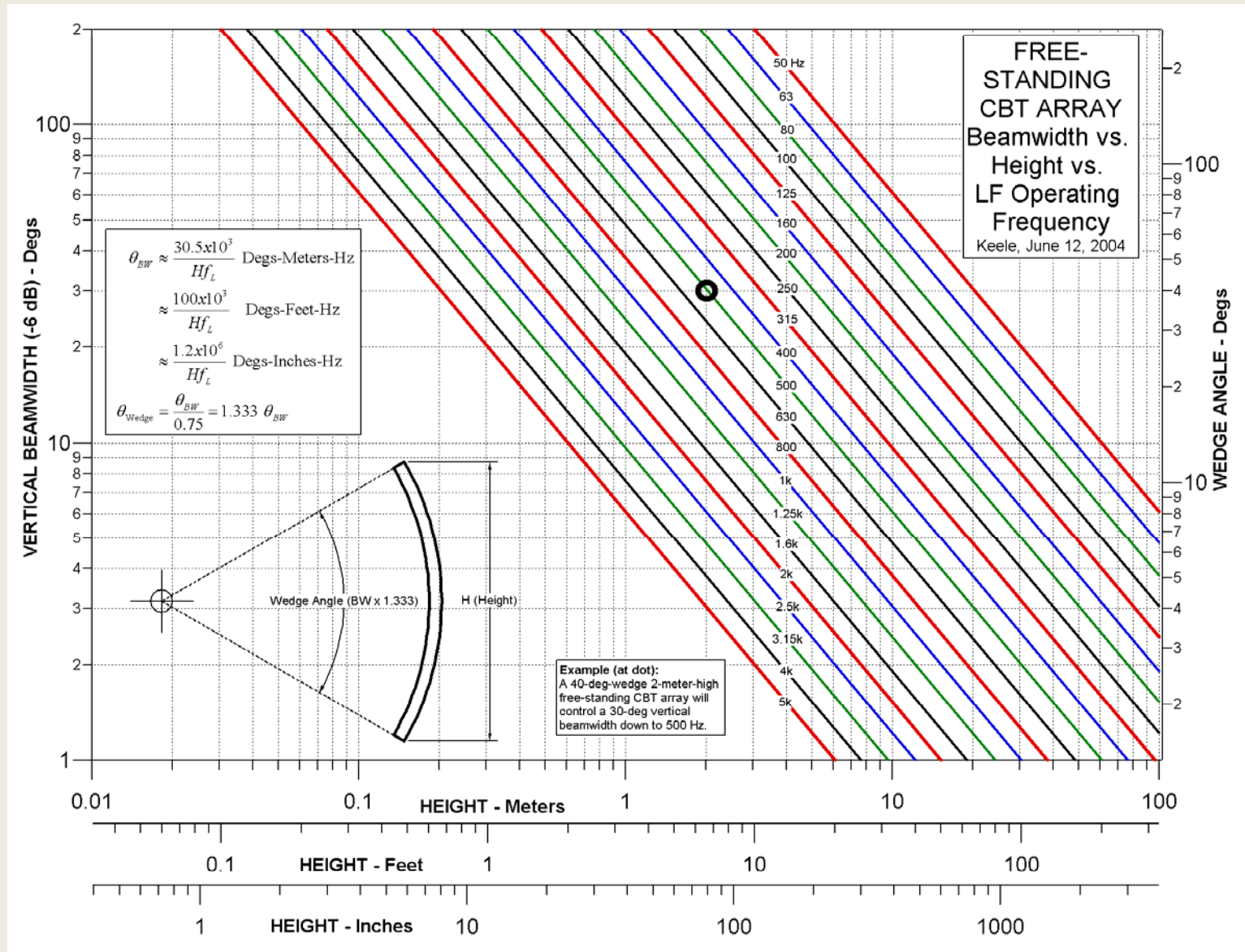

GROUND-PLANE CBT ARRAY: Angle vs. Height vs. LF Control Frequency

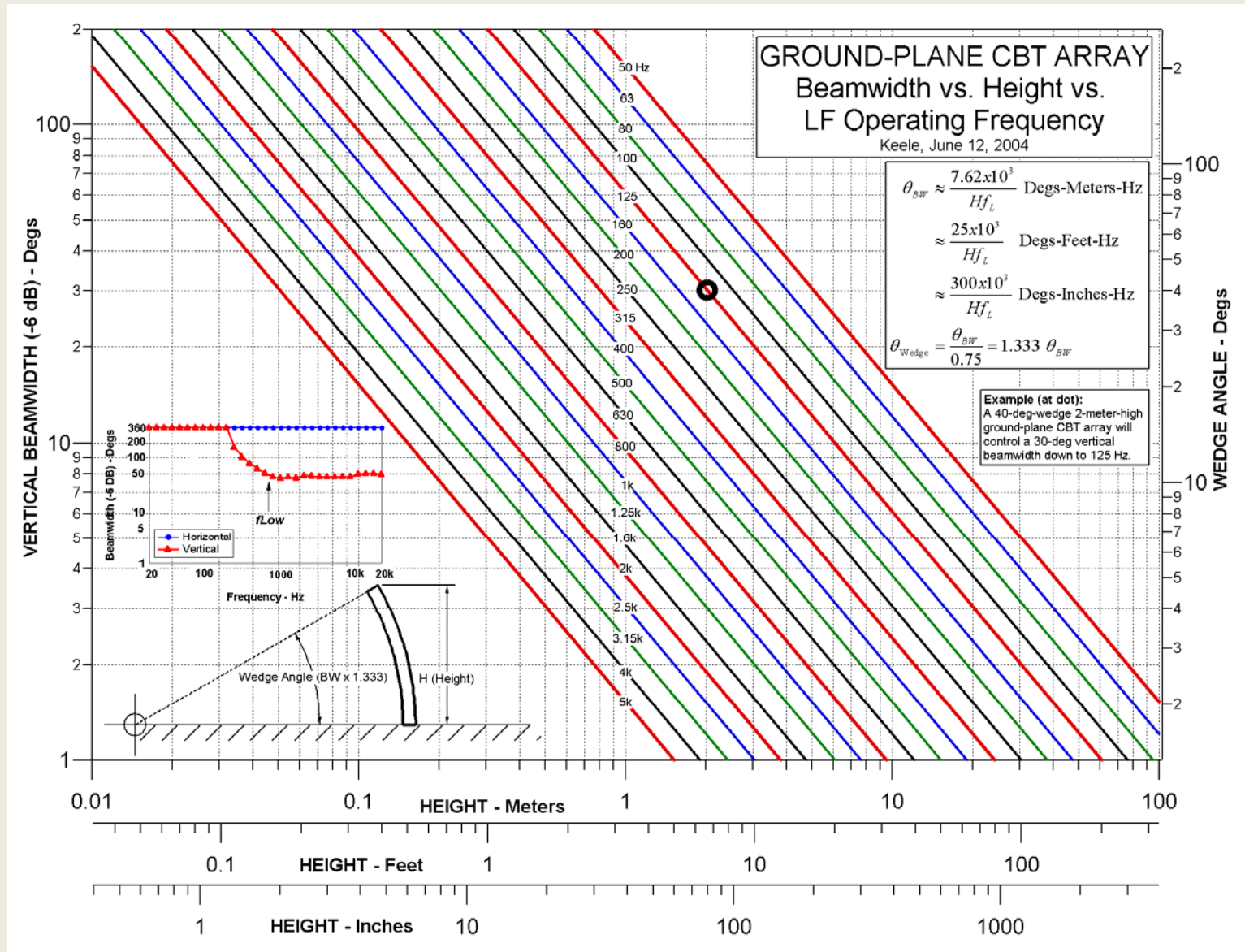

Implementation Using Individual Drivers



 HVI B15 1" Shielded Aluminum Mid/Tweeter List: \$8.00 Now: \$4.49 Ships Free on Most Orders Over \$99	 Yang Reed W1-18135 1" Neodymium Full Range Driver List: \$9.99 Now: \$0.47 Ships Free on Most Orders Over \$99	 Yang Reed W1-18035 2" Neodymium Poly Full Range Driver List: \$9.99 Now: \$8.50 Ships Free on Most Orders Over \$99
 Vifa A130G-21-04 5 1/4" Coaxial w/ Audax Tweeter 4 Ohm List: \$17.00 Special: \$9.00 Ships Free on Most Orders Over \$99	 Peerless B33097 2" Full Range Driver 4 Ohm List: \$20.00 Now: \$9.10 Ships Free on Most Orders Over \$99	 Peerless B30970 2" Full Range Driver 4 Ohm List: \$20.00 Now: \$9.95 Ships Free on Most Orders Over \$99

2" Full Range Aluminum Cone Neodymium Driver

Save 52%
 Special Price: \$3.00 (1-24)
 \$3.00 (25-99)
 \$2.00 (100+)

Qty: **Add To Cart**

FREE SHIPPING

Ships Free on Most Orders Over \$99

TRADE & BULK QUANTITIES AVAILABLE. No Stock/Backorder

Speaker Components Show All Manufacturers FULLRANGE ~1*

Displaying 1 to 2 (of 2 products) Result Pages: 1

Model	Product Name	Price	Buy Now
NSW1-205-8A	Aurasound NSW1-205-8A 1" Extended Range	\$15.20	Out of Stock
B15	Hi-VI B15 Full Range	\$5.00	Out of Stock

Displaying 1 to 2 (of 2 products) Result Pages: 1

HORN LOADED TWEETERS

 Pyle Pro PH25 3" x 3" Horn Tweeter List: \$12.00 Now: \$6.93 Ships Free on Most Orders Over \$99	 Constant Directivity Horn Now: \$9.25 In Stock	 Pyle Pro PH24 4" x 4" Horn Mid Tweeter List: \$14.00 Now: \$10.50 Ships Free on Most Orders Over \$99
 3 3/8" Bullet Tweeter Now: \$11.00 Ships Free on Most Orders Over \$99	 Pioneer AH150-517 3 1/2" Horn Tweeter Now: \$12.32 In Stock	 Heavy Duty Titanium Super Tweeter TW44 Now: \$16.75 In Stock

Speaker Components Show All Manufacturers FULLRANGE ~2*

Displaying 1 to 10 (of 10 products) Result Pages: 1

Model	Product Name	Price	Buy Now
NSW2-326-8A-120	Aurasound NSW2-326-8A-120 2" Full Range with Solder Pads	\$19.90	Out of Stock
NSW2-326-6A1	Aurasound NSW2-326-6A1 2" Extended Range	\$19.90	Out of Stock
A26	Hi-VI A26 2" Full Range	\$11.35	Out of Stock
B26	Hi-VI B26 2" Full Range, Lower Color	\$11.70	Out of Stock

Implementation Using Individual Drivers



Micro Speakers and Receivers

Home

Connectors

Speakers

EMI-RFI Solutions

News & Events

White Papers

Sales Reps

Distributors

Contact Regal

Check Stock

Site Map

Check Regal Stock

CHECK STOCK

Click Here for Regal

QUICK SHIP

Orders in by 4:00PM shipped the same day!

Regal RS, RM, and RR Series Micro Speakers and Receivers

Specifications

Features

- Extremely Small Size
- Rugged
- Wide Range
- High Power (Speakers)

Applications

- PDA's
- Cell Phones
- Annunciator Panels
- Handheld Games



Model	Size (mm)		Imp. (ohms)	Resonant Freq. (f ₀)	Freq. Range	Sensitivity	Power Input (watts)		Frame	
	Dia.	Hgt.					Hz	Hz		dB (+/-3dB)
Speakers (may also be used as receivers and buzzers)										
RS-1534A-ENL	15	3.4	8	1050	600-20K	77	0.5	1.0	Metal	
PDF File: Specifications/drawings (RM-1534A-NL.pdf, 1 page, 63k)										
RM-1332-NL	13	3.2	8	1200	670-20K	81	0.5	0.8	Plastic	
PDF File: Specifications/drawings (RS-1332-NL.pdf, 1 page, 50k)										
RM-1543SP-NL (spring contacts)	15	4.3	8	1100	620-20K	78	0.7	1.0	Metal	
PDF File: Specifications/drawings (RM-1543SP-NL; 1 page, 57k)										
Receivers										
RR-1000A-NL	10	4.2	32	-	100-4K	110	.01	.05	Metal	
PDF File: Specifications/drawings (RR-1000A.pdf, 1 page, 67k)										

Implementation Using Individual Drivers

DRIVERS:

LARGE DRIVER:

Harman Multimedia 57mm (2.25")
Odyssey 7 used in Apple iMac.

33mm (1.3") inverted metal dome.
(Bandwidth: 100 Hz to 20 kHz)

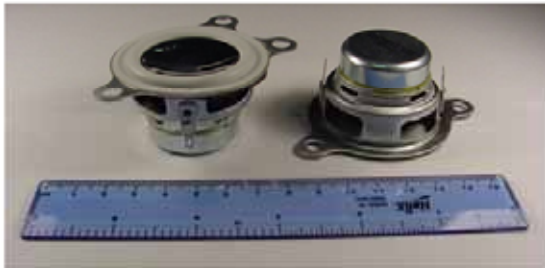

SMALL DRIVER:

Harman Multimedia 19mm (0.75")
Odyssey 2 used in Toshiba and Dell
Laptop Computers.

12.5 mm (0.5") inverted metal dome.
(Bandwidth: 400 Hz to 20 kHz)



Keele's CBT Prototypes

Keele's CBT Prototype Arrays and Renderings (Don Keele Sept. 27, 2008)

Keele's First CBT Array Prototype of 2003



Keele's Second CBT Array Prototype of 2004 (CBT45)



- CBT 45°-Arc Curved Array
- Ground-Plane Design
- Height = 1.35m (54in)
- Uses 48 AKG XXL-V5 Headphone Drivers
- Operating range of 100 Hz to 12 kHz
- Composed of Eight 5.625° Straight Segments
- Each segment is constructed of 4in-ID clear PVC pipe (www.harvelplastics.com)
- Each module tuned to 120 Hz
- Provides a 34° vertical beamwidth (-6 dB)
- Controls coverage down to 200 Hz
- Qualifies for a true wide-band constant directivity source

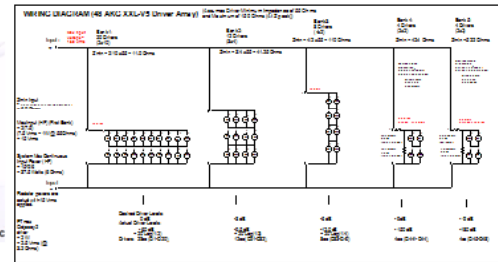

Keele's Third CBT Array Prototype of 2004 (CBT30)

Keele's Third CBT Array Prototype of 2004 (CBT30) CBT30 Array Description

CBT30 Ground-Plane CBT Array

- 1.9 m (6.25') High
- 30° Circular Arc
- Uses 90 Each Odyssey 2, 18 mm (0.71") Dia. Harman Multimedia Drivers
- Uses 34 Each Warrior 53 mm (2.1") Dia. Harman Multimedia Drivers
- Crossover: 1 kHz
- Operating range of 100 Hz to 20 kHz
- Passive Shading Network
- Qualifies as a true wide-band constant directivity source! (200 Hz and Up)
- Narrow 22° Vertical Coverage (-6 dB)
- Wide 180° Horizontal Coverage
- Extremely Even Coverage! Up-Down, Right-Left, Far-Near
- Can Play Very Loud and Clean!

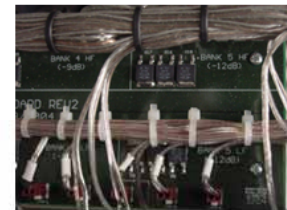
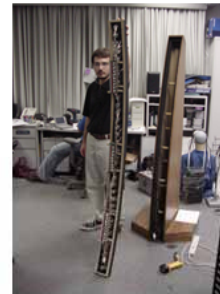

Keele's Fourth CBT Array Prototype of 2005 (Ittersbach Array). Uses all Automotive Transducers. 16 each 100mm MMX Cone Drivers and 24 each 100mm EDPL Drivers. (Electro-Dynamic Planar Loudspeaker).



Rob Franks built special 4 Ohm units.

Kurt Solland Rendering of Apr. 2003
Note: This is not a ground plane array!



Keele's First CBT Array Prototype

Uses 18 each
2.25" drivers, and
50 each 0.75" dia
wide-range drivers
(used in Toshiba
laptops).



Remember the Harman Kardon Soundsticks PC Multimedia Speakers?

Keele's Second CBT Array Prototype of 2004 (CBT45)

- **DESCRIPTION:**
- CBT 45°-Arc Curved Array
- Ground-Plane Design
- Height = 1.35m (54in)
- Uses 48 AKG XXL-V5 Headphone Drivers
- Operating range of 100 Hz to 12 kHz
- Composed of Eight 5.625° Straight Segments
- Each segment is constructed of 4in-ID clear PVC pipe (www.harvelplastics.com)
- Provides a 34° vertical beamwidth (-6 dB)
- Controls coverage down to 200 Hz
- Qualifies for a true wide-band constant directivity source!

CBT45 Array CAD Drawing

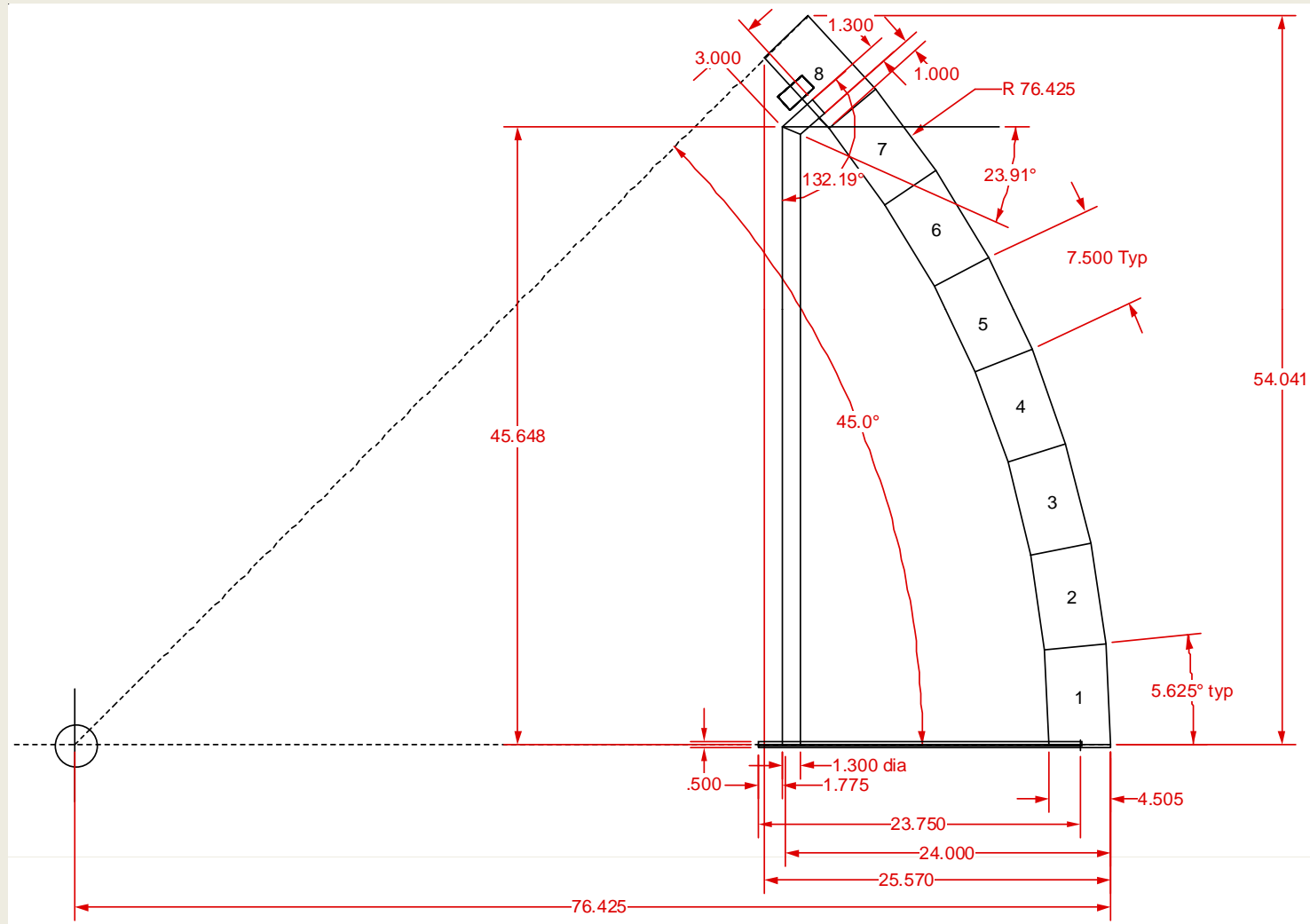

CBT45 Photos



1/14/2010

Keele - CBT Boston Presentation

78

CBT45 Photos



1/14/2010

Keele - CBT Boston Presentation

79

CBT45 Photos



1/14/2010

Keele - CBT Boston Presentation

80

CBT45 Array Wiring Diagram

(Implements stepped and truncated Legendre Shading)

Rated Impedance: 8 Ohms
Minimum Impedance: 6.4 Ohms

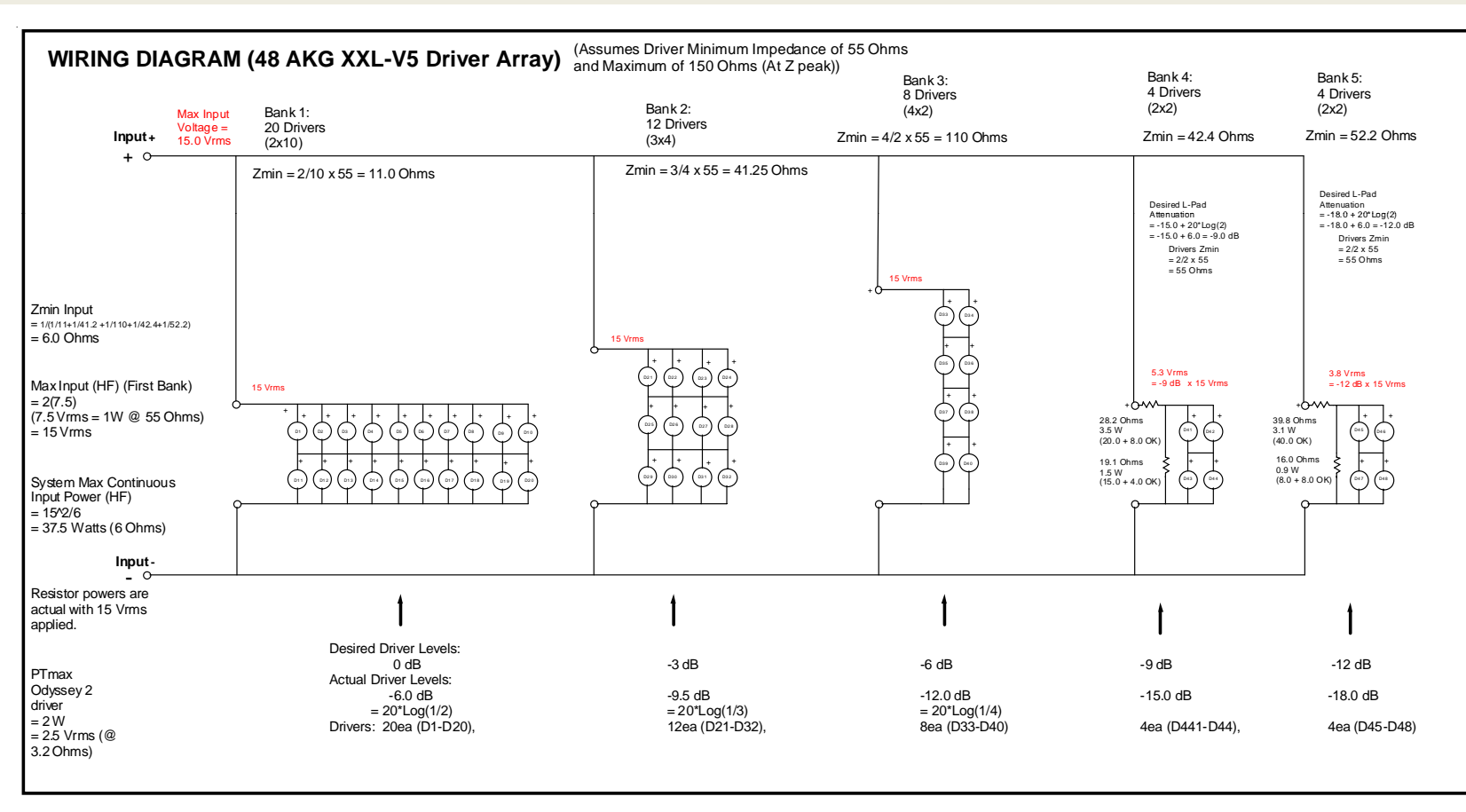

CBT45 Driver Layout and Shading

Total of 48 Drivers

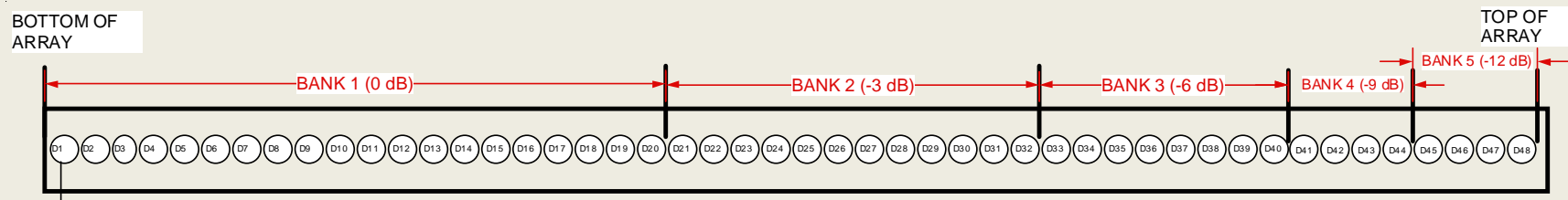

CBT45 Measured Voltage Drive of Shading Network

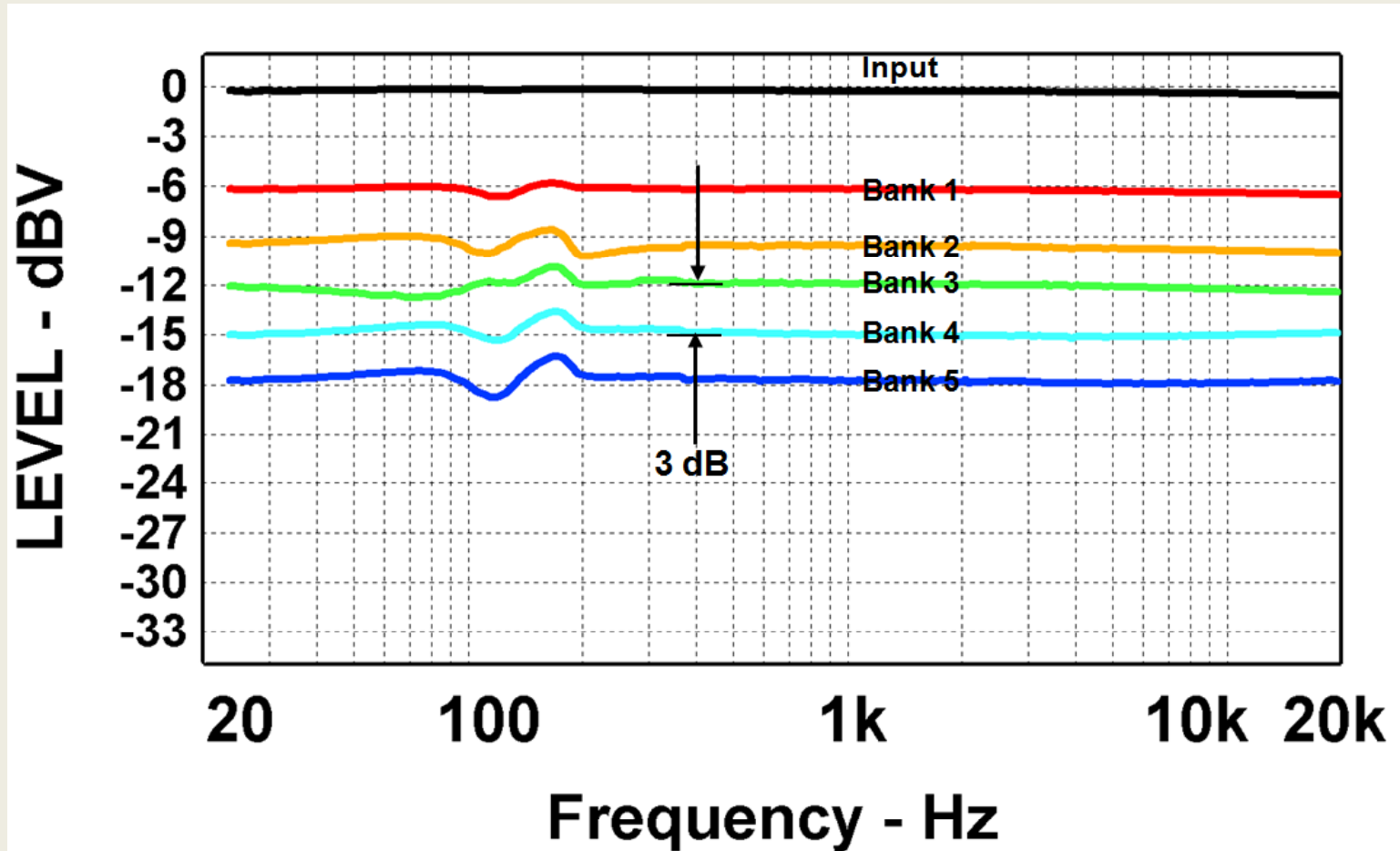

AKG Headphone Driver Response

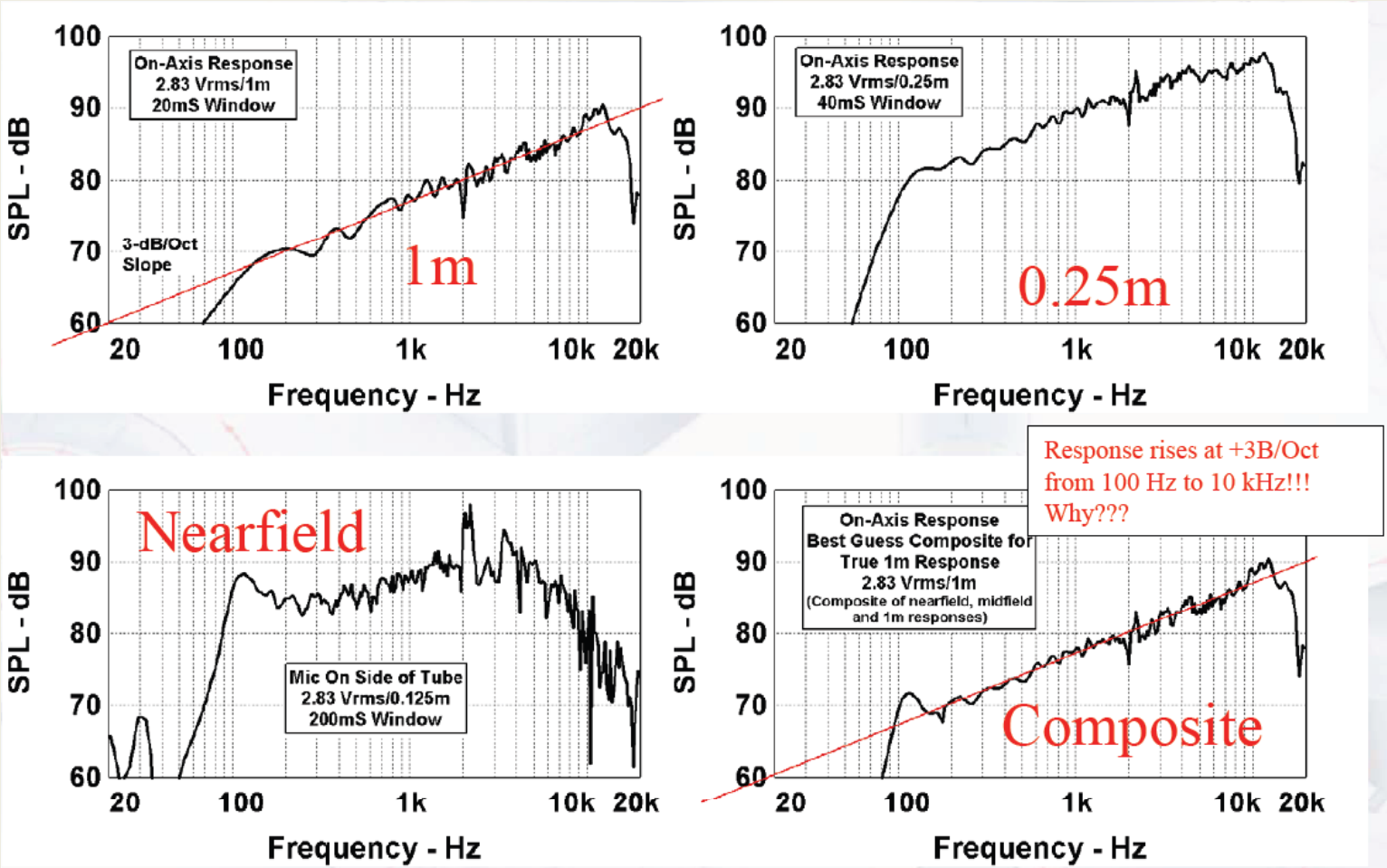

CBT45 Measured System Impedance

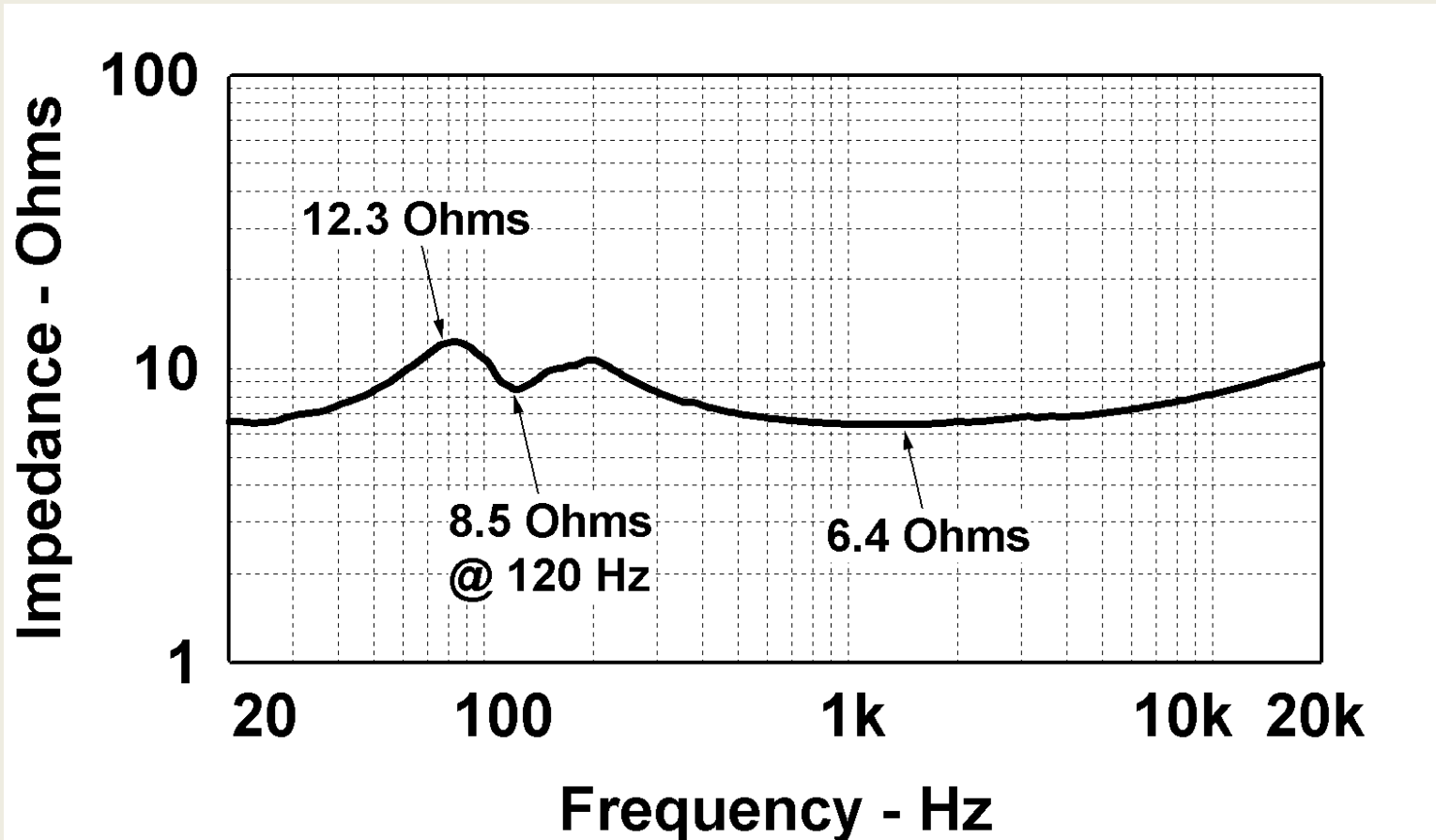

Keele's Third CBT Array Prototype of 2004 (CBT30)

- **CBT30 Ground-Plane CBT Array**
 - 1.9 m (6.25') High
 - 30° Circular Arc
 - Uses 90 Each Odyssey 2, 18 mm (0.71") Dia. Harman Multimedia Drivers
 - Uses 34 Each Warrior 53 mm (2.1") Dia. Harman Multimedia Drivers
 - Crossover: 1 kHz
 - Operating range of 100 Hz to 20 kHz
 - Passive Shading Network
 - Qualifies as a true wide-band constant directivity source! (200 Hz and Up)
 - Narrow 22° Vertical Coverage (-6 dB)
 - Wide 180° Horizontal Coverage
 - Extremely Even Coverage! Up-Down, Right-Left, Far-Near
 - Can Play Very Loud and Clean!

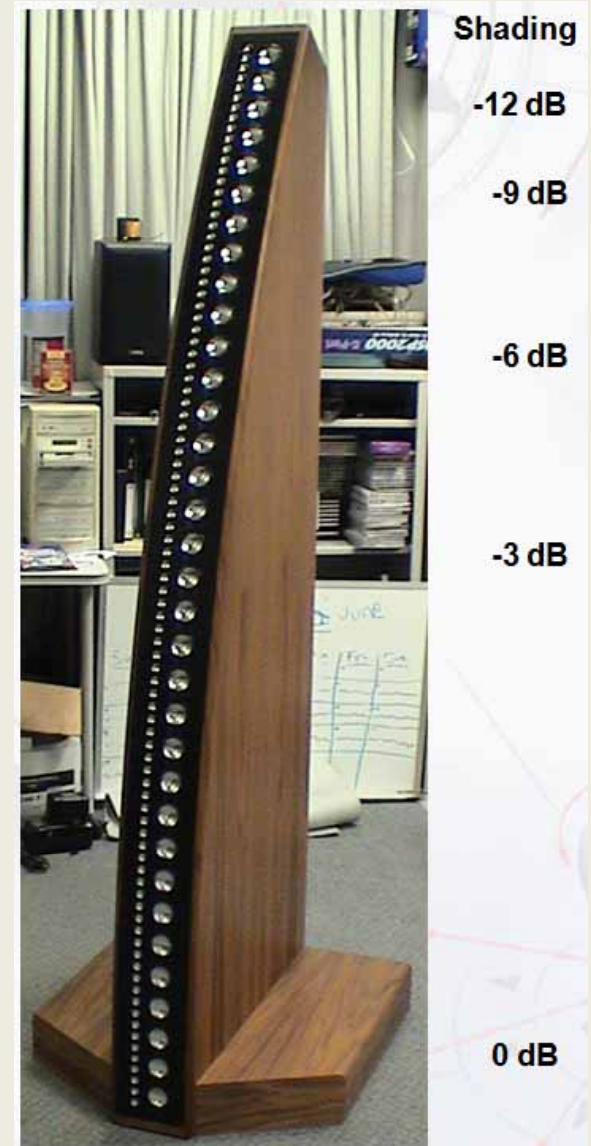

Keele's Third CBT Array Prototype of 2004 CBT30

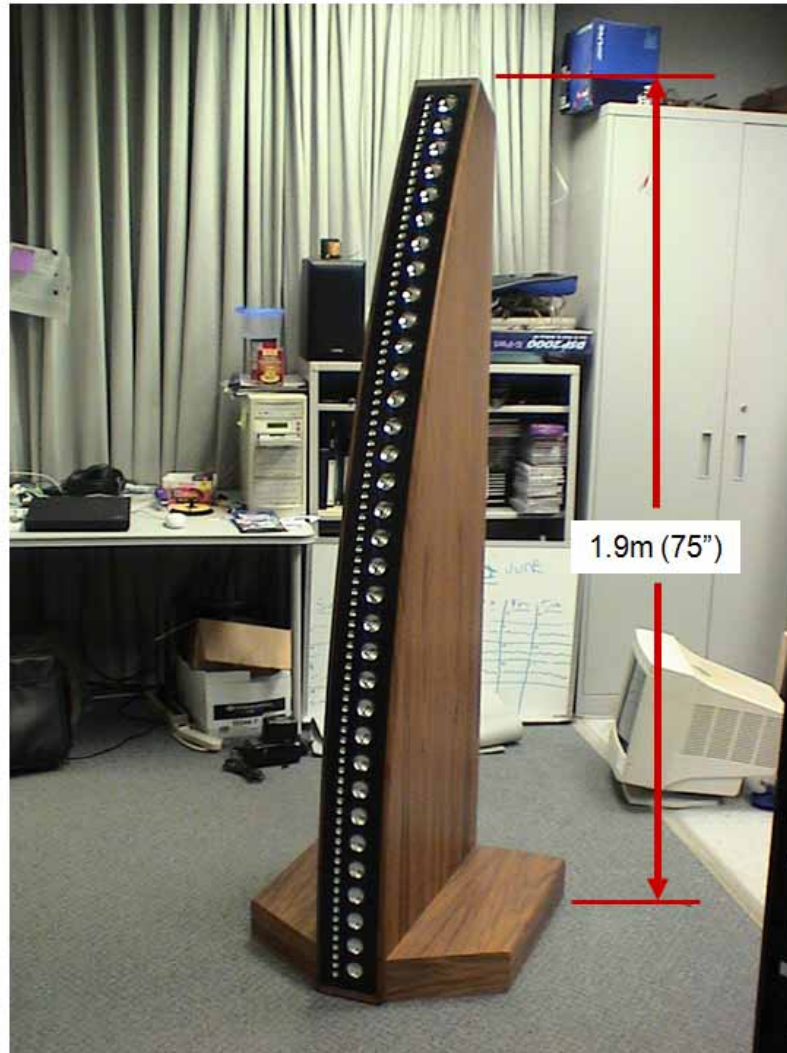

Keele's Third CBT Array Prototype of 2004 CBT30



Keele's Third CBT Array Prototype of 2004 CBT30

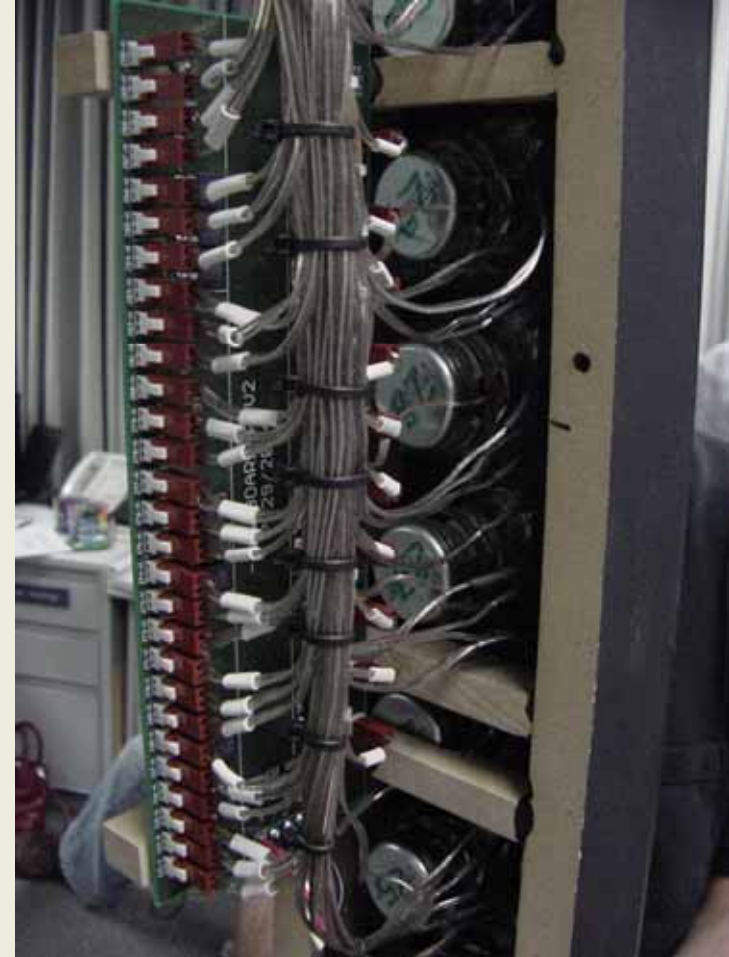

Keele's Third CBT Array Prototype of 2004 CBT30

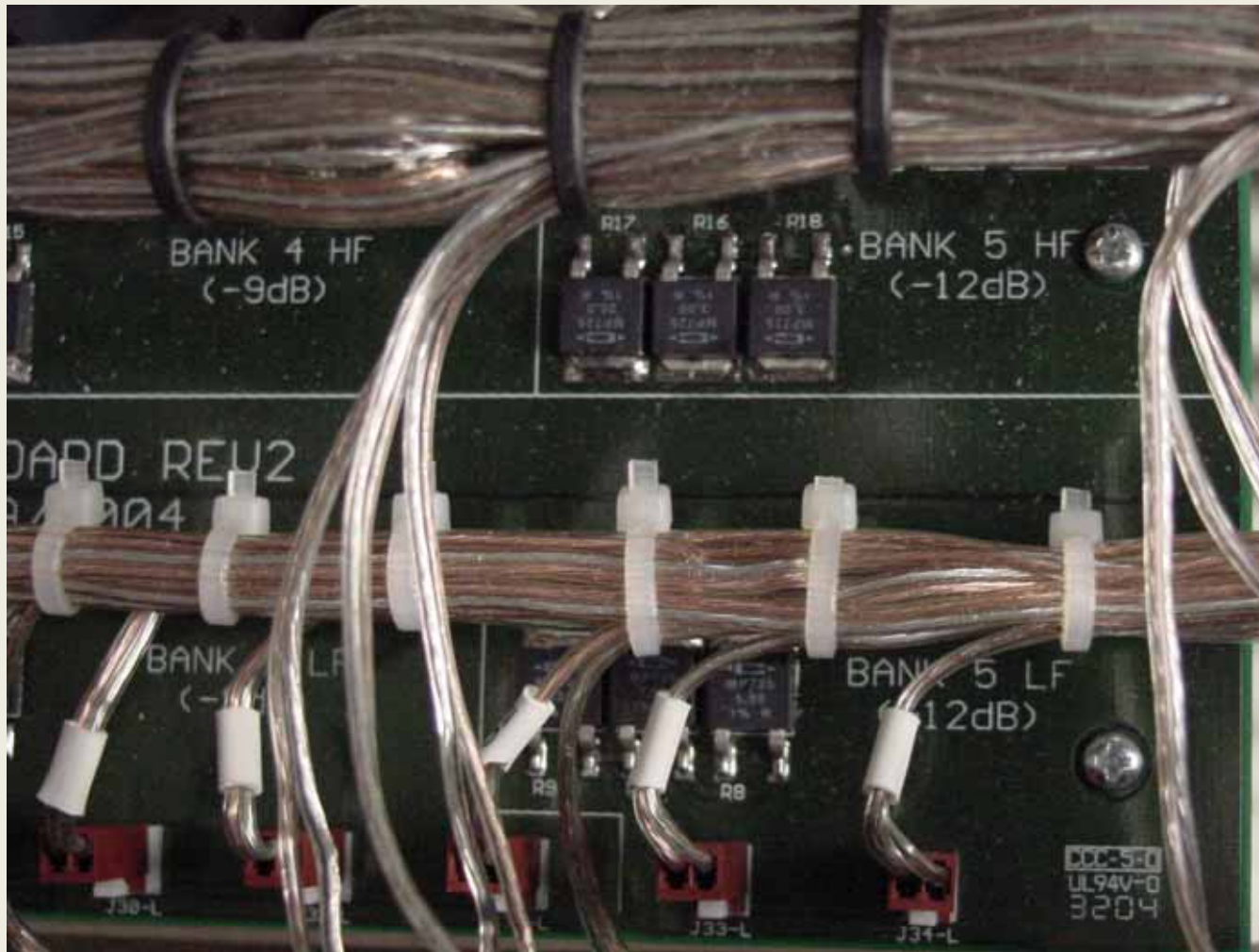

CBT45 vs. Revel Salon (Measured Both with and Without Carpet)



Photos Revel Salon (Measured Both with and Without Carpet)



Revel Salon Description

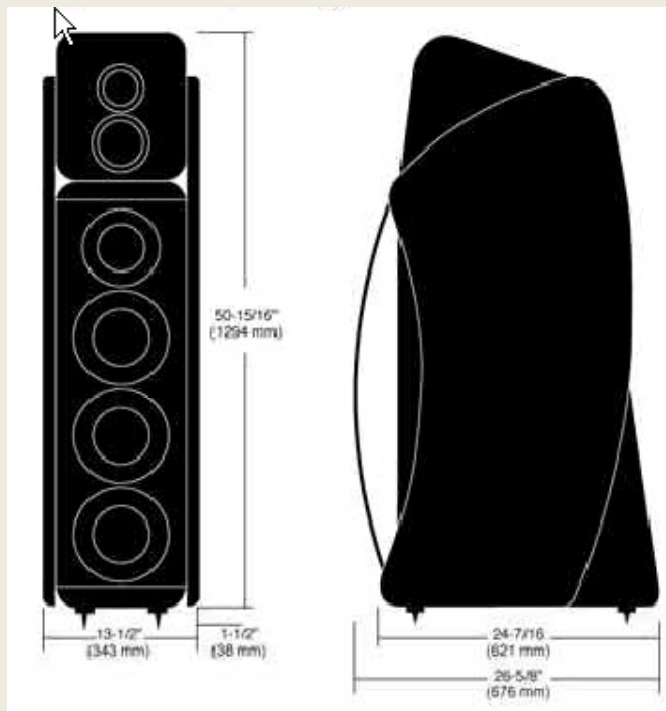

Salon Product Specifications

Sensitivity:	86 dB SPL, with 2.83 RMS @ 1 meter, 4 pi (anechoic).
Impedance:	6 ohms nominal, 3 ohms minimum
Filters (crossover):	4-way, 24 dB/octave (4th-order) acoustic response at 125 Hz, 450 and 2.2 kHz
In-room Frequency Response:	± 1 dB from 25 Hz to 12 kHz
In-room response relative to target response:	± 0.75 dB from 25 Hz to 20 kHz
First-reflections Response:	± 1 dB from 25 Hz to 17 kHz
Listening Window Response:	± 1.5 dB from 25 Hz to 18 kHz
Low Frequency Extension:	-10 dB @ 17 Hz, -6 dB @ 20 Hz (-3 dB @ 24 Hz)
Dimensions:	50 15/16" (1294 mm) H x 13 1/2" (342.9 mm) W x 26 9/16" (674.7 mm) D. Add 1 1/2" (38 mm) for spikes.
Shipping Weight:	approx. 240 lbs. (108.9 kg)

Revel Salon
Response vs Height
at 0.1m Front of System
(Over Perfectly Reflective Ground-Plane Surface)

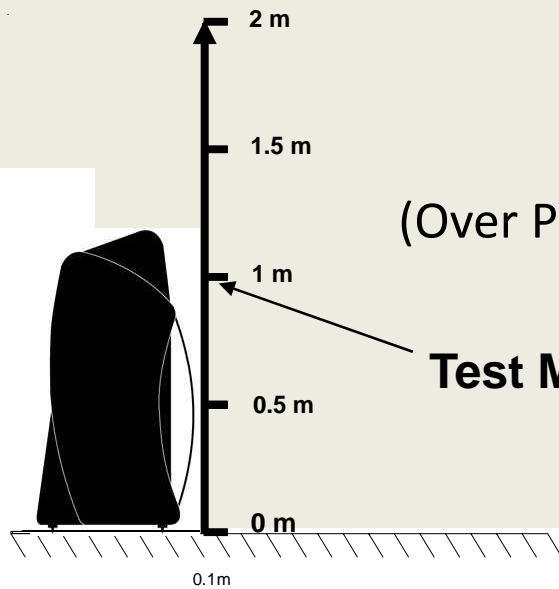

50ms Window

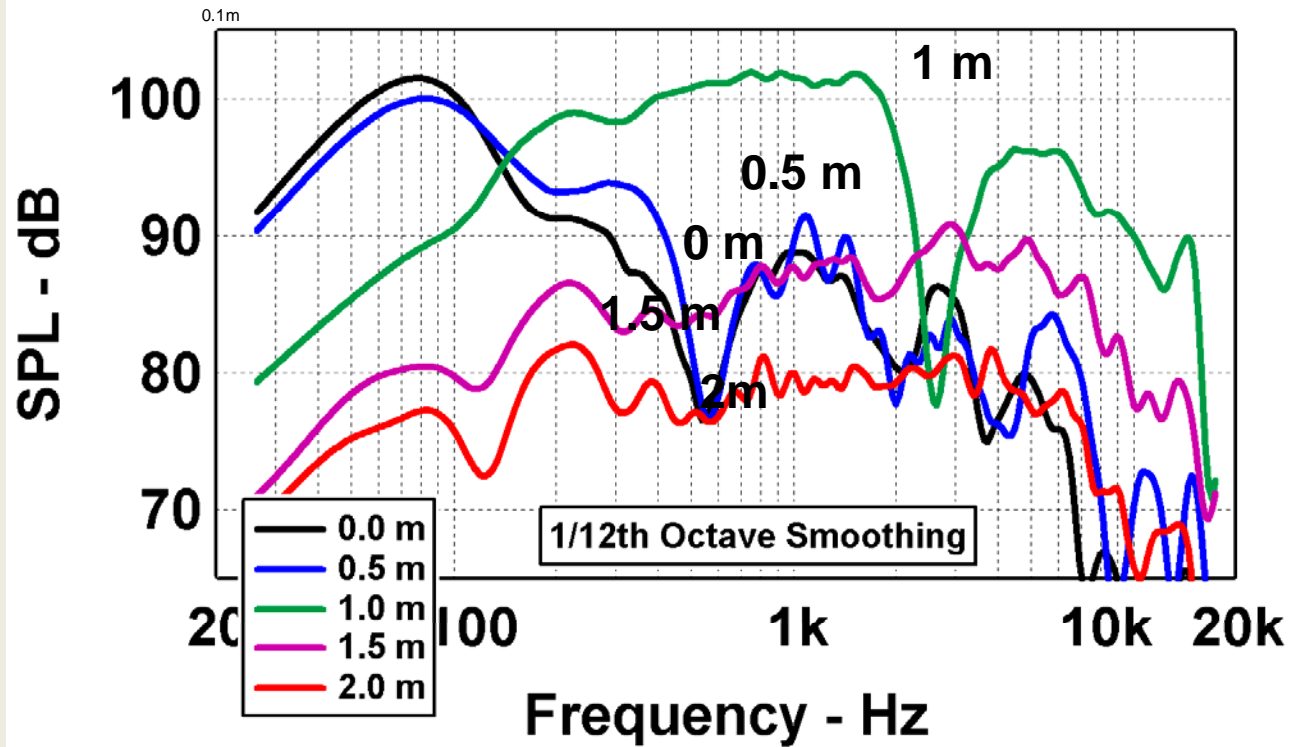

Revel Salon Response vs Height at 1m Front of System (Over Perfectly Reflective Ground-Plane Surface)

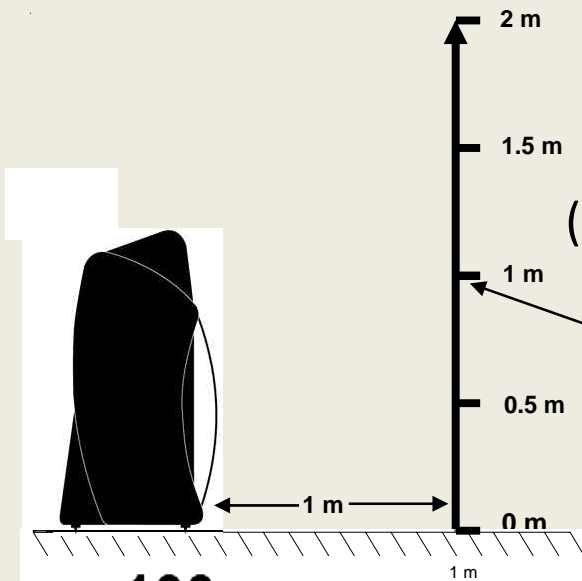

Test Mic Locations

50ms Window

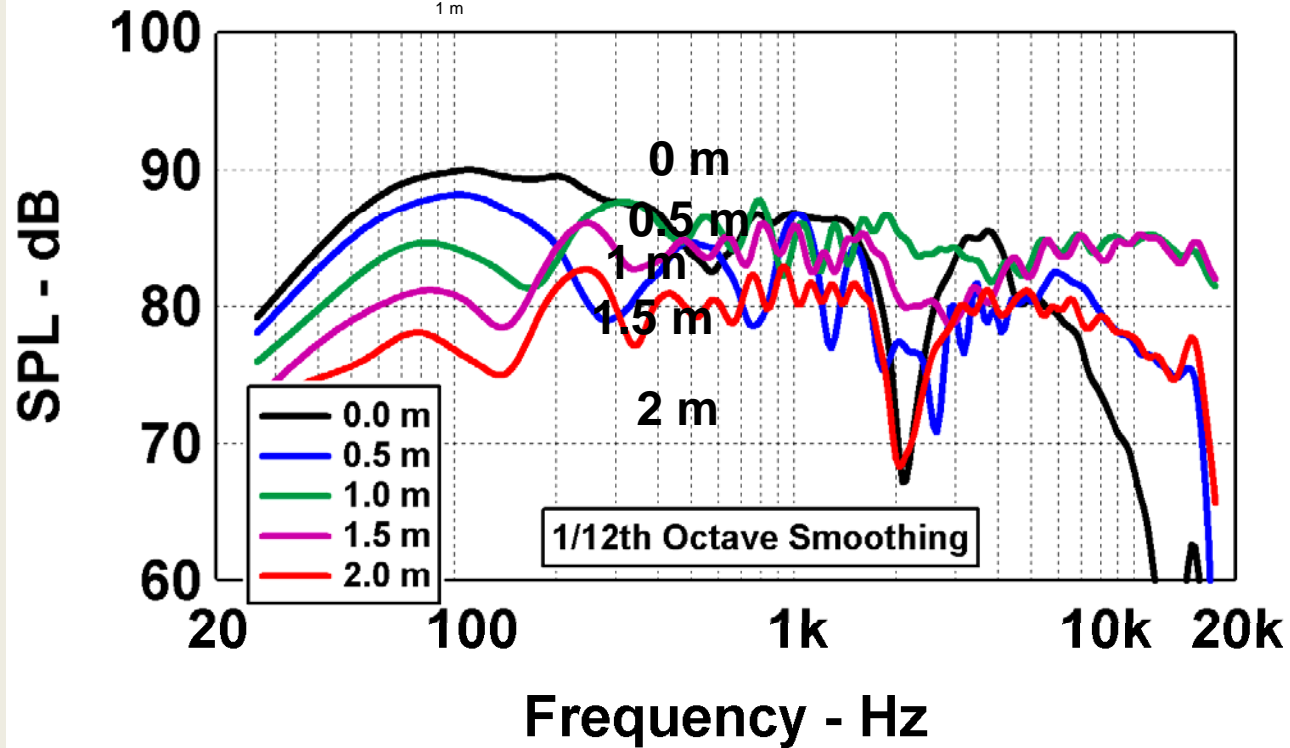

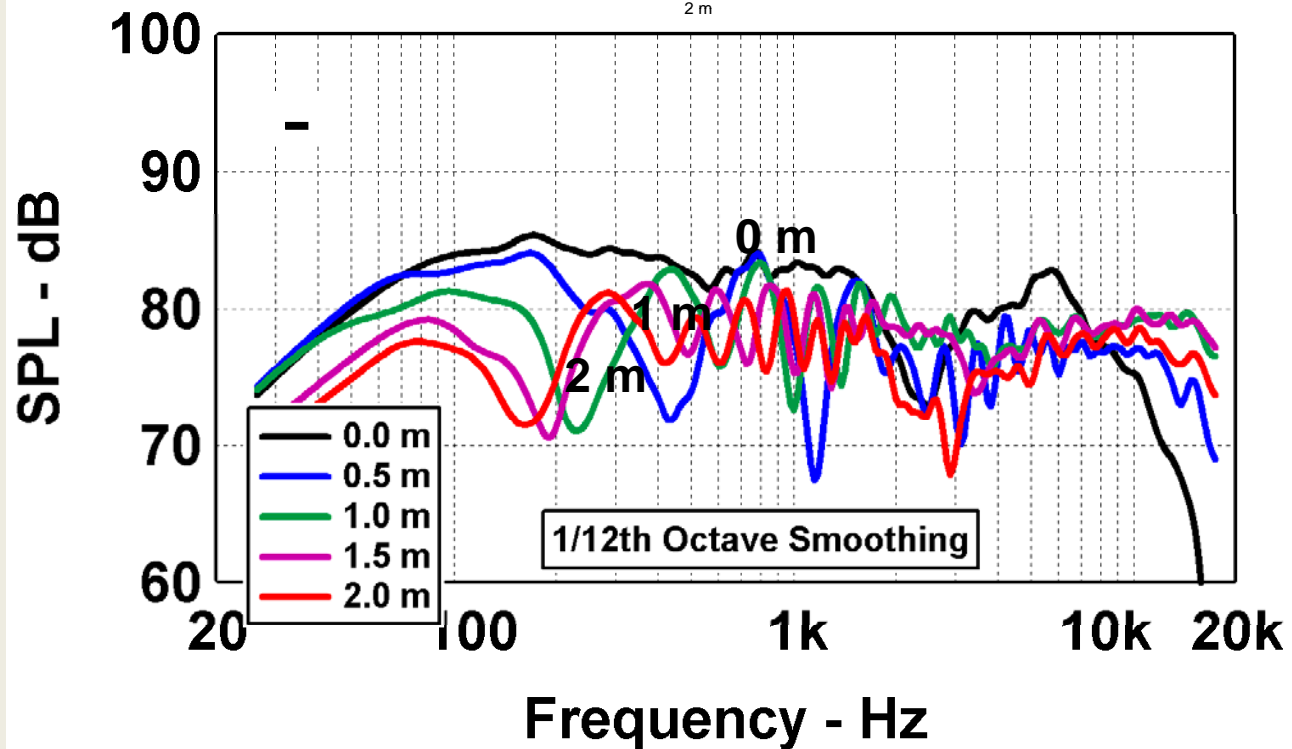
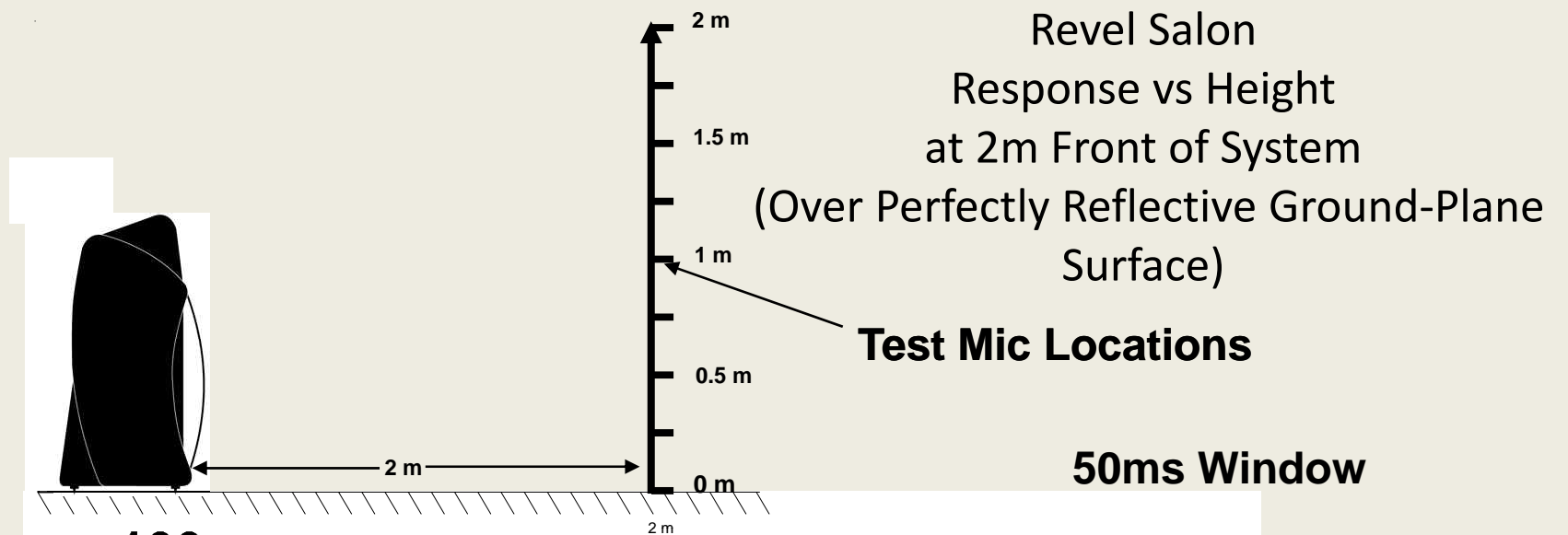

Revel Salon
Response vs Height
at 3m Front of System
(Over Perfectly Reflective Ground-Plane
Surface)

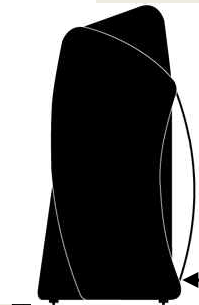

3 m

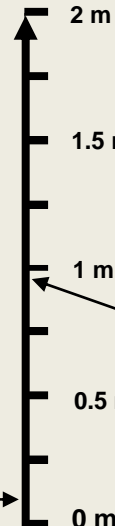

Test Mic Locations

50ms Window

3 m

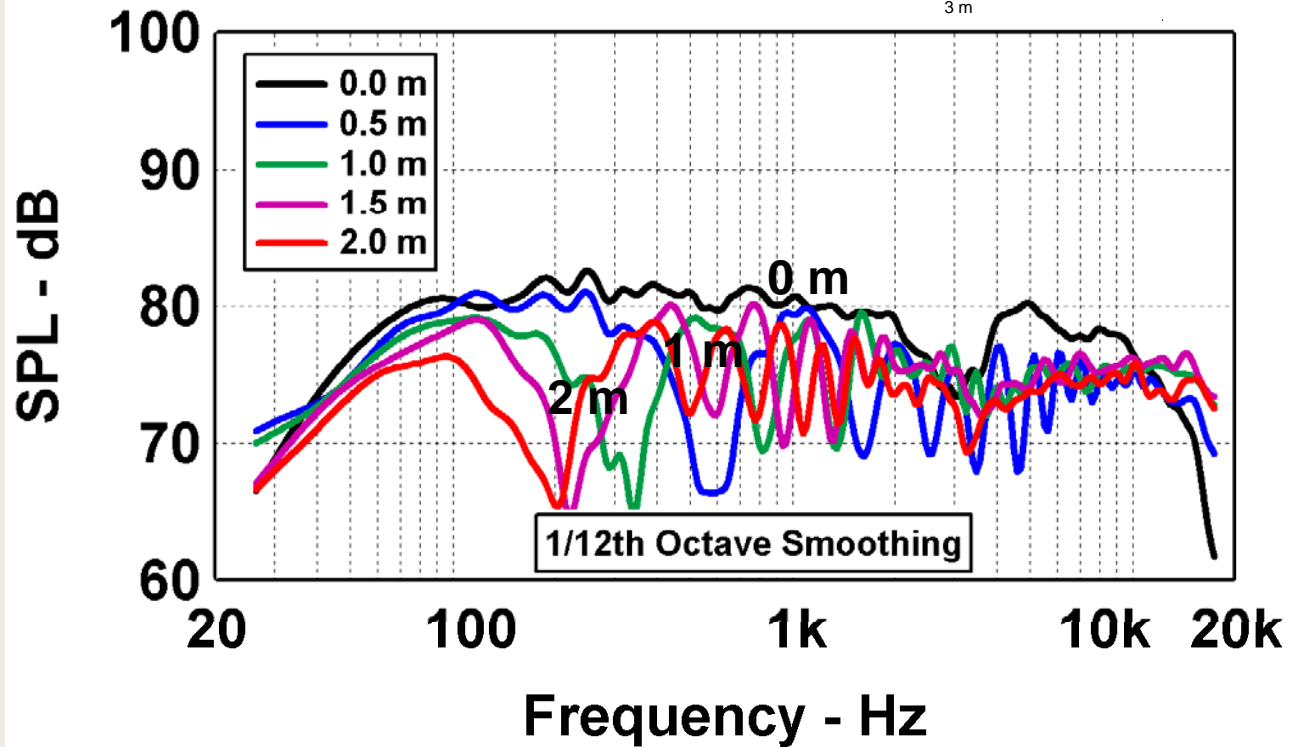

CBT45

Response vs Height
at 0.1m in Front of Array
(Over Perfectly Reflective
Ground-Plane Surface)

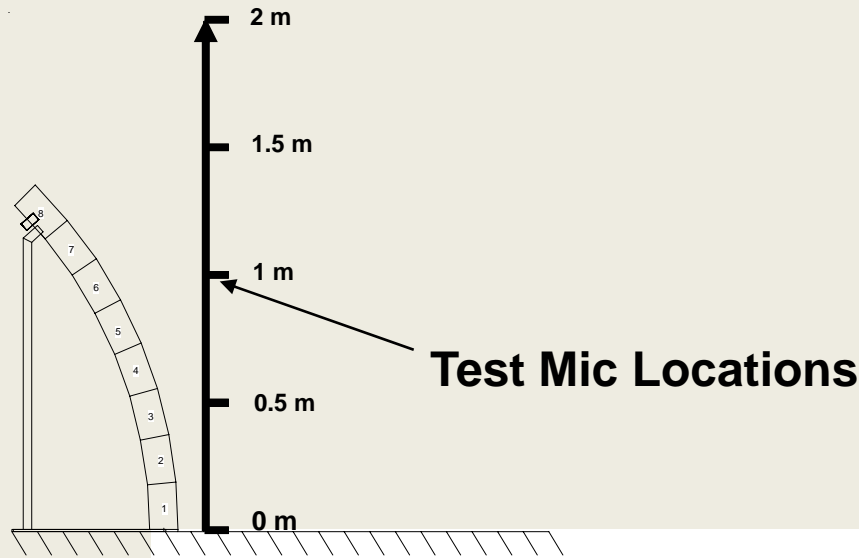

25ms Window

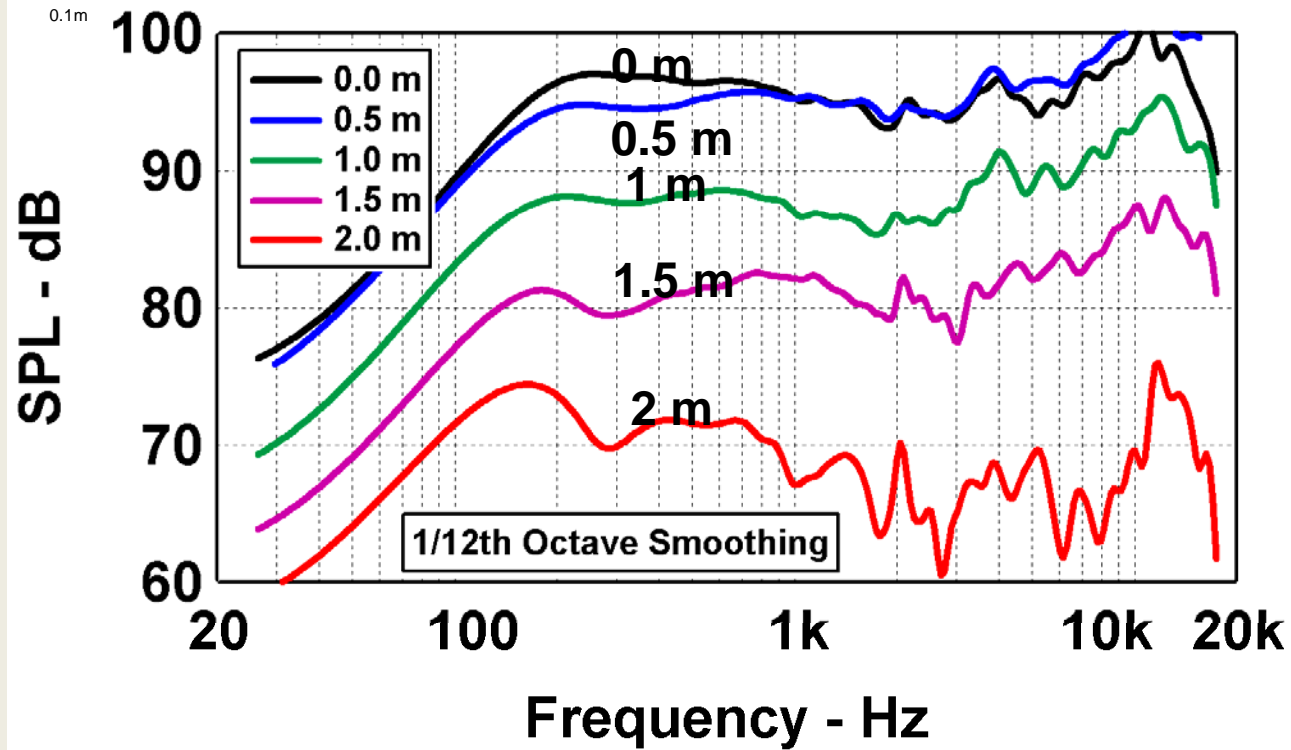

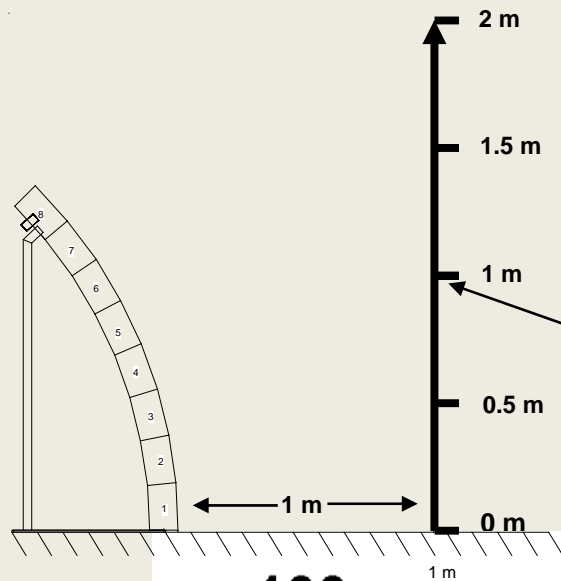

CBT45
 Response vs Height
 at 1m in Front of Array
 (Over Perfectly Reflective
 Ground-Plane Surface)

Test Mic Locations

25ms Window

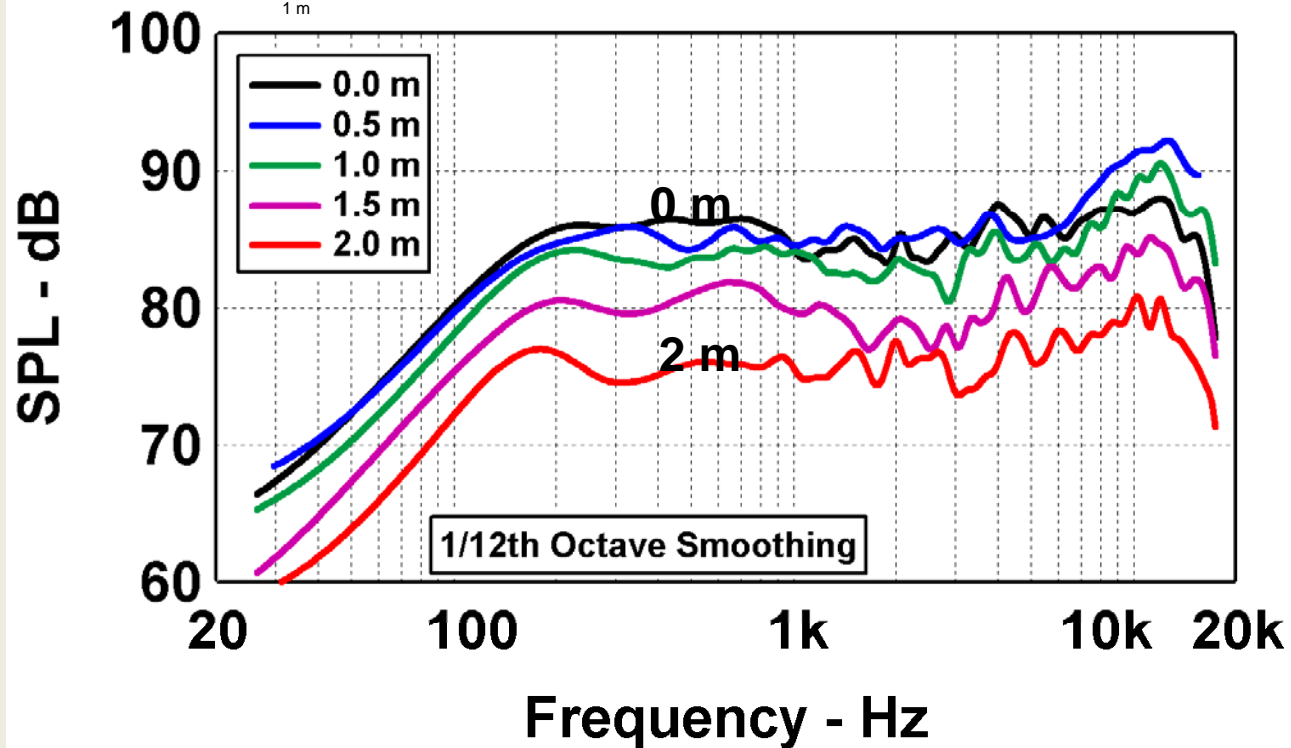

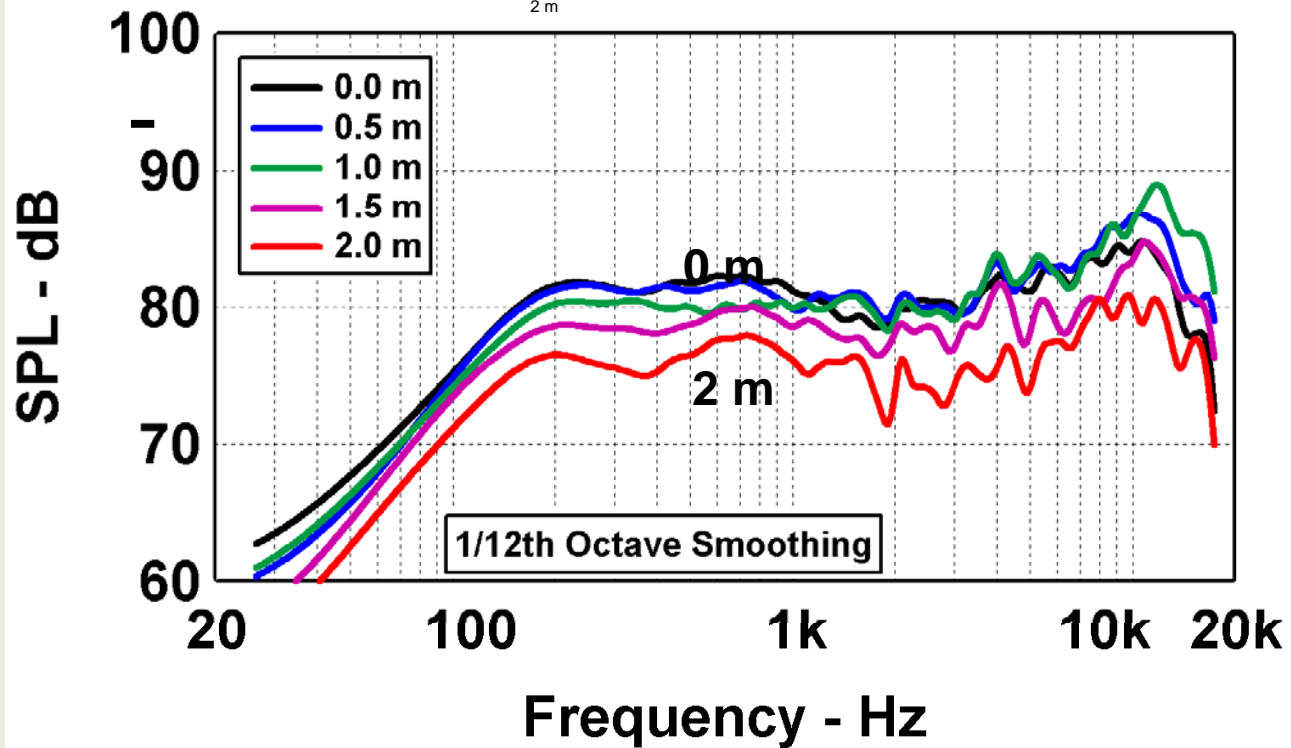
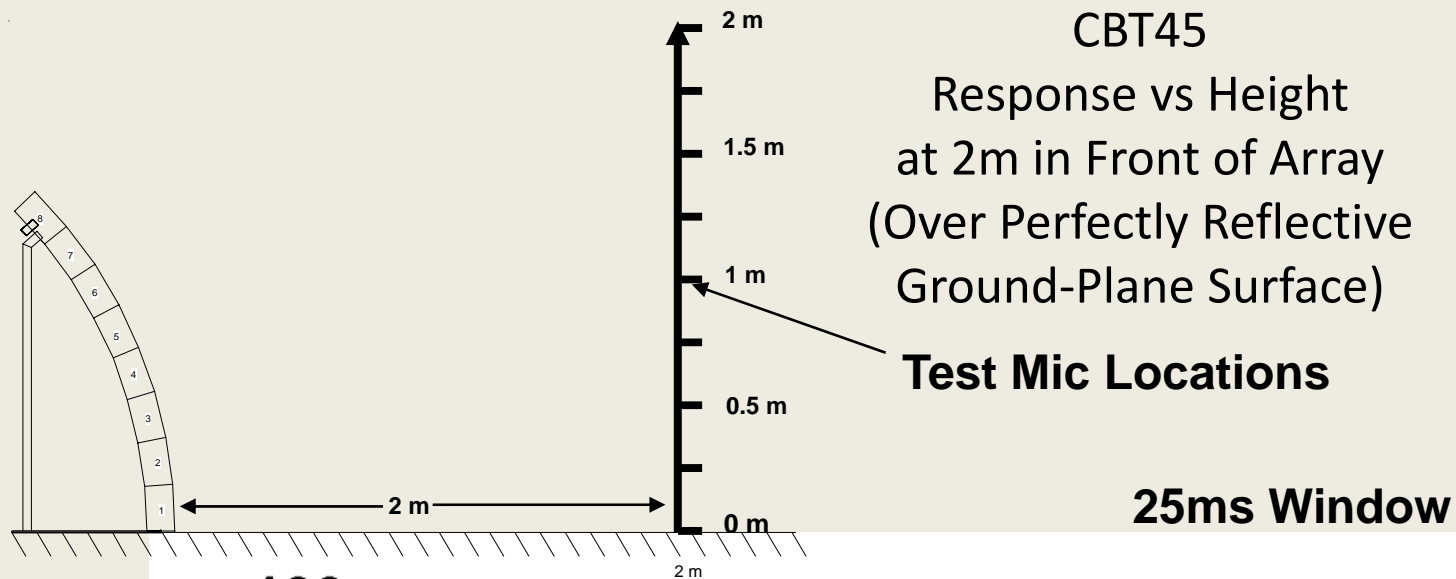

CBT45

Response vs Height
at 3m in Front of Array
(Over Perfectly Reflective
Ground-Plane Surface)

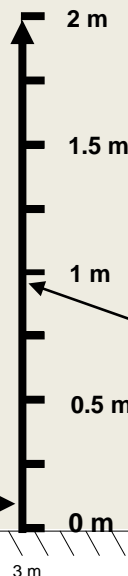
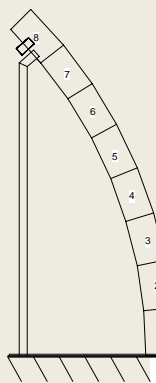

Test Mic Locations

25ms Window

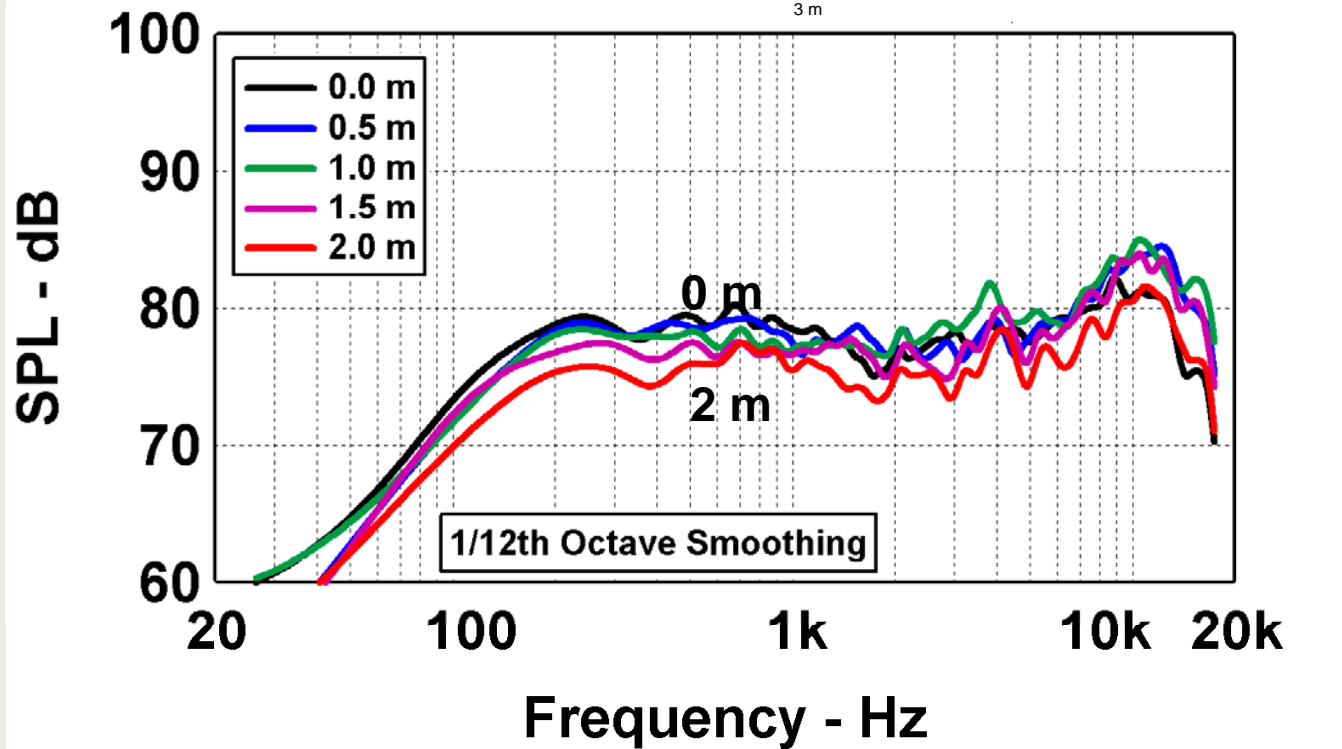

Revel Salon vs CBT45, 2m On Axis, 1m High (Over Perfectly Reflective Ground-Plane Surface)

CBT45 Array

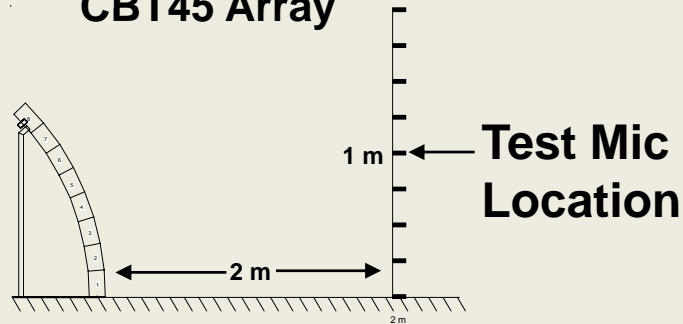

Revel Salon

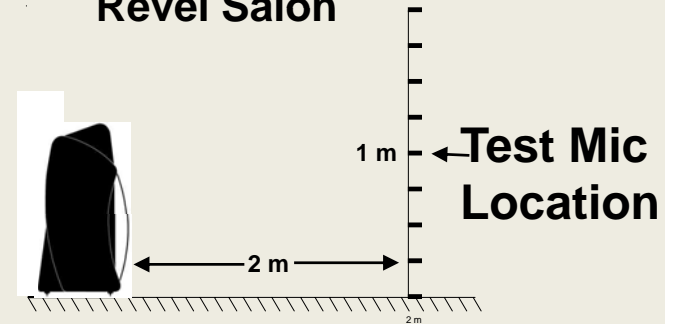

100ms Time Window

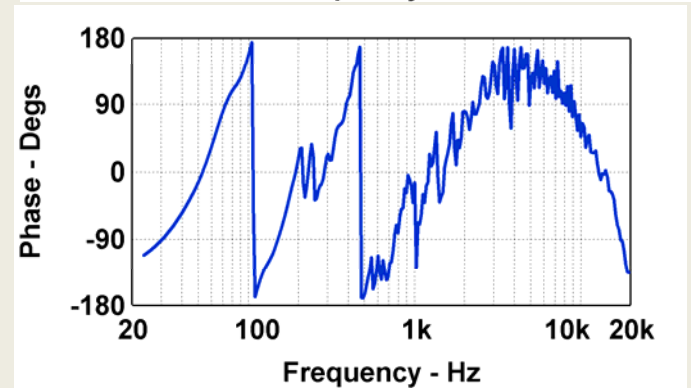
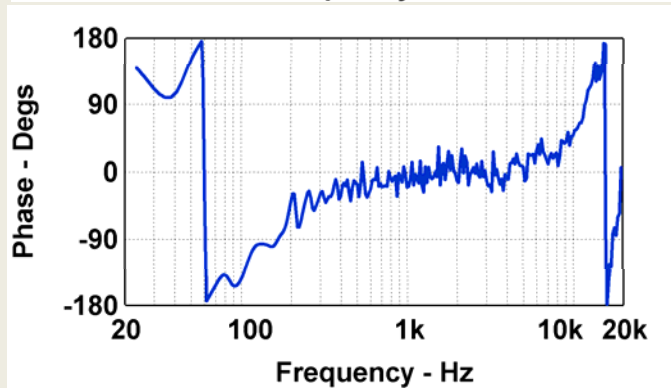
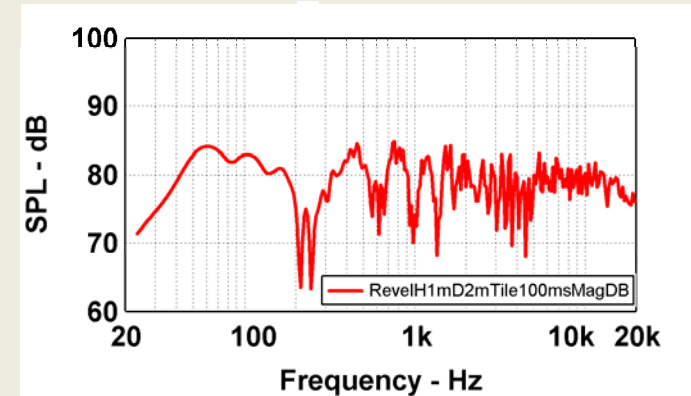
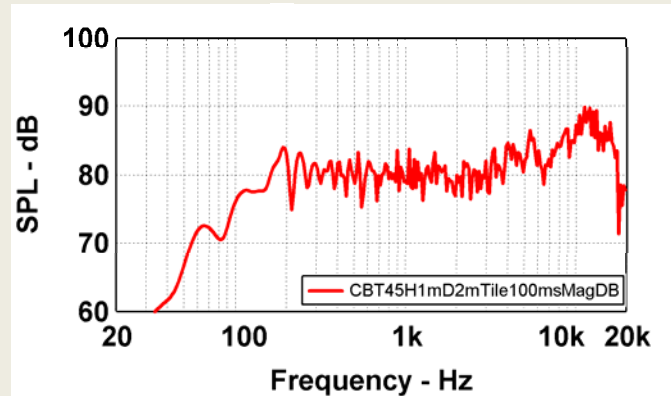

CBT45 Horizontal Off-Axis Frequency Response

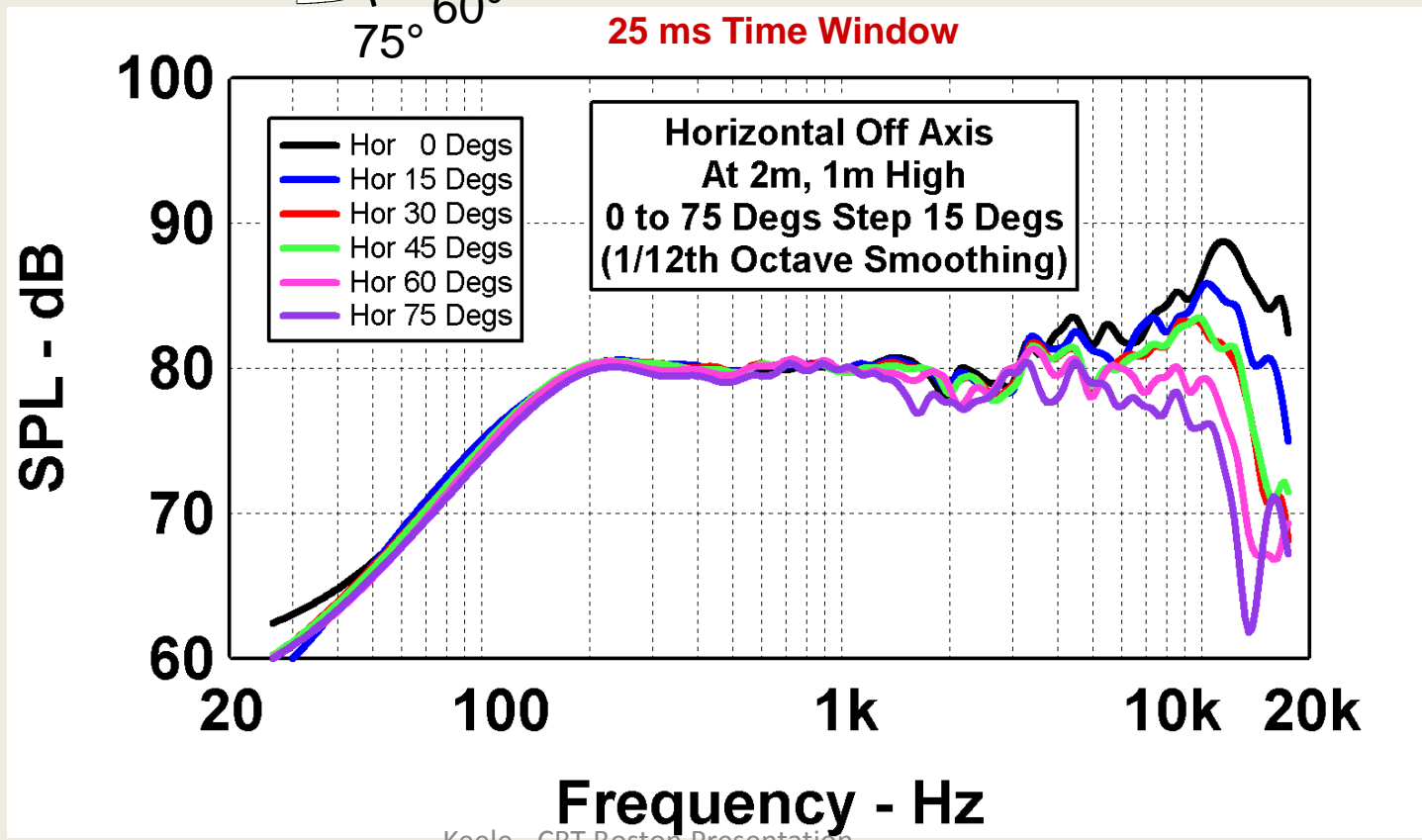
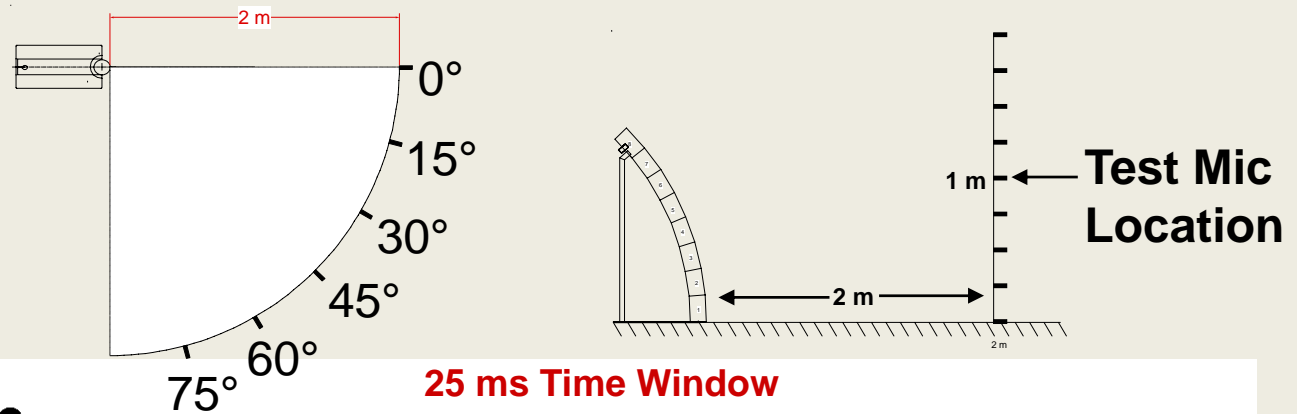

Response vs Distance at Seated Height 1m (40 in)

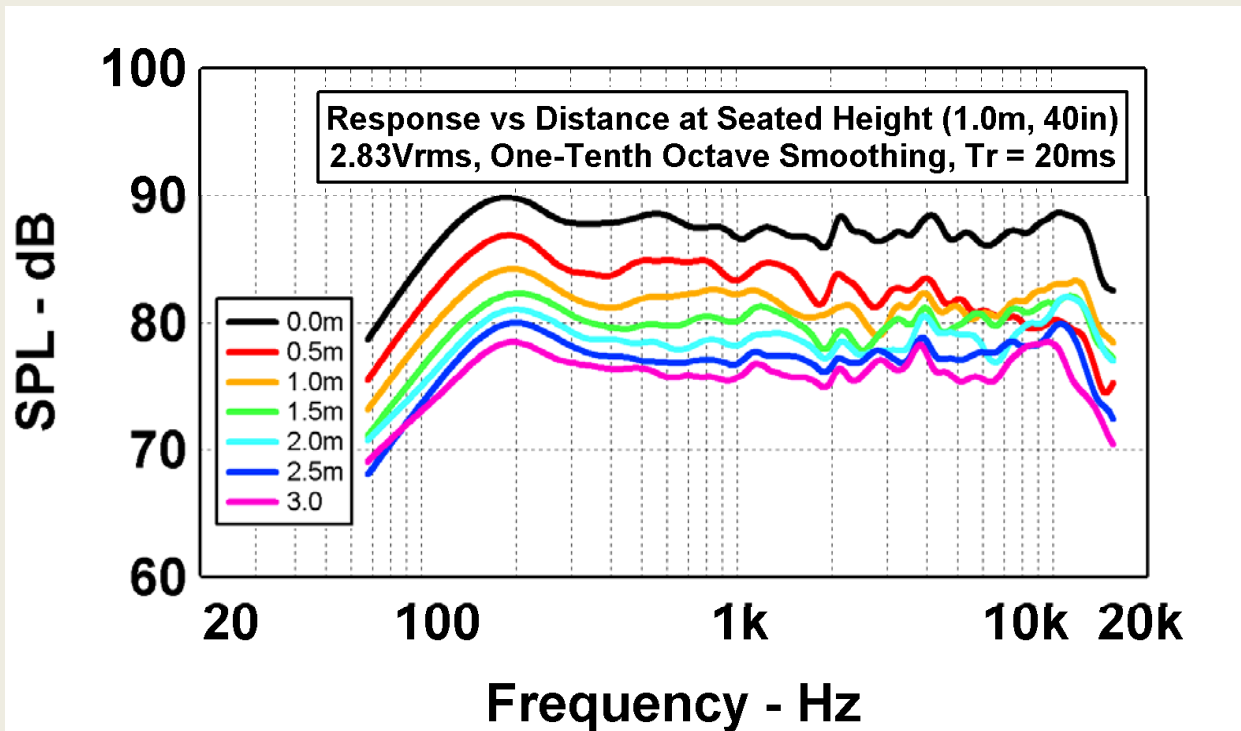
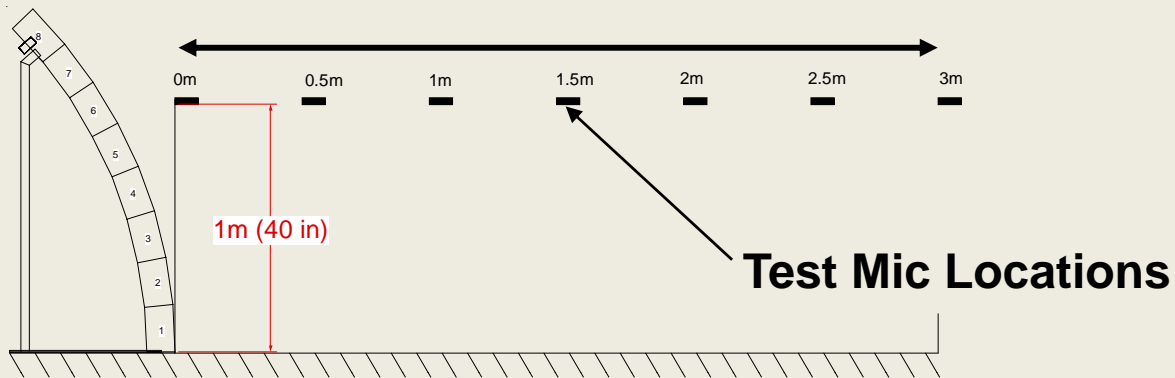

Response vs Distance at Standing Height

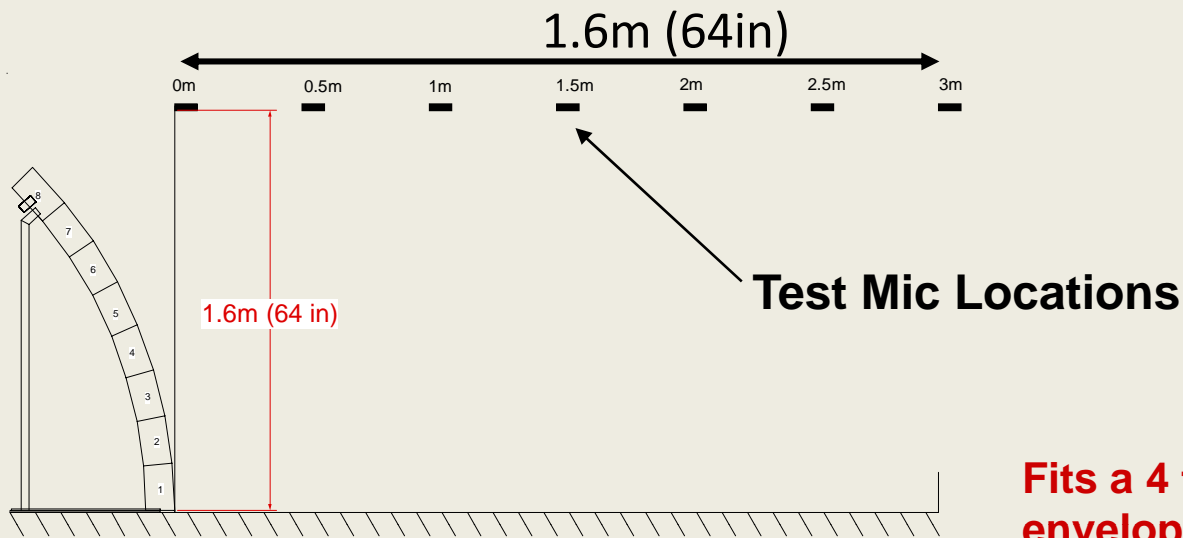

Fits a 4 to 5 dB response envelope from near to far!

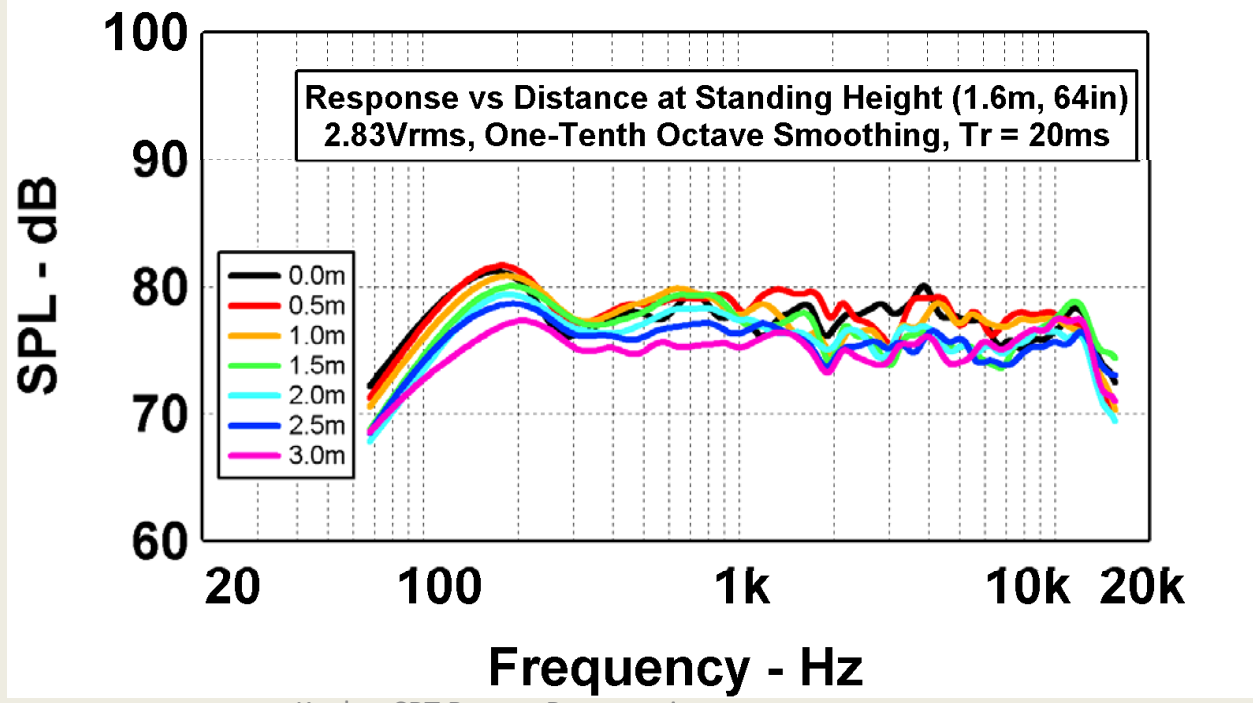

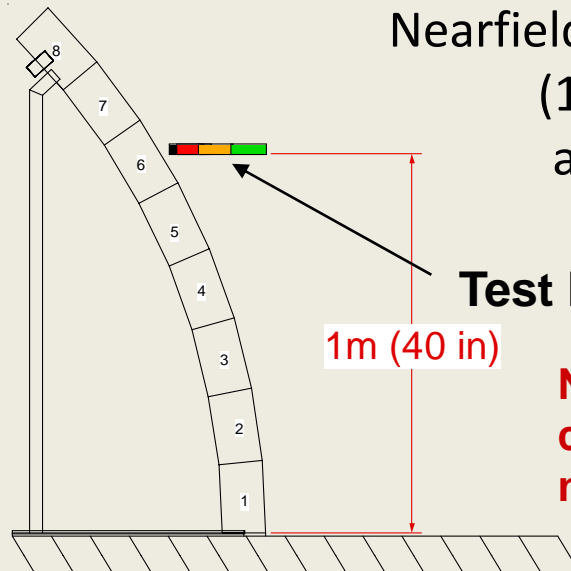

Nearfield Response vs Distance

(1", 2", 4" and 8")

at Seated Height

1m (40 in)

Test Mic Locations

1m (40 in)

Note uniformity of very-close response! Is a perfect near-field monitor!

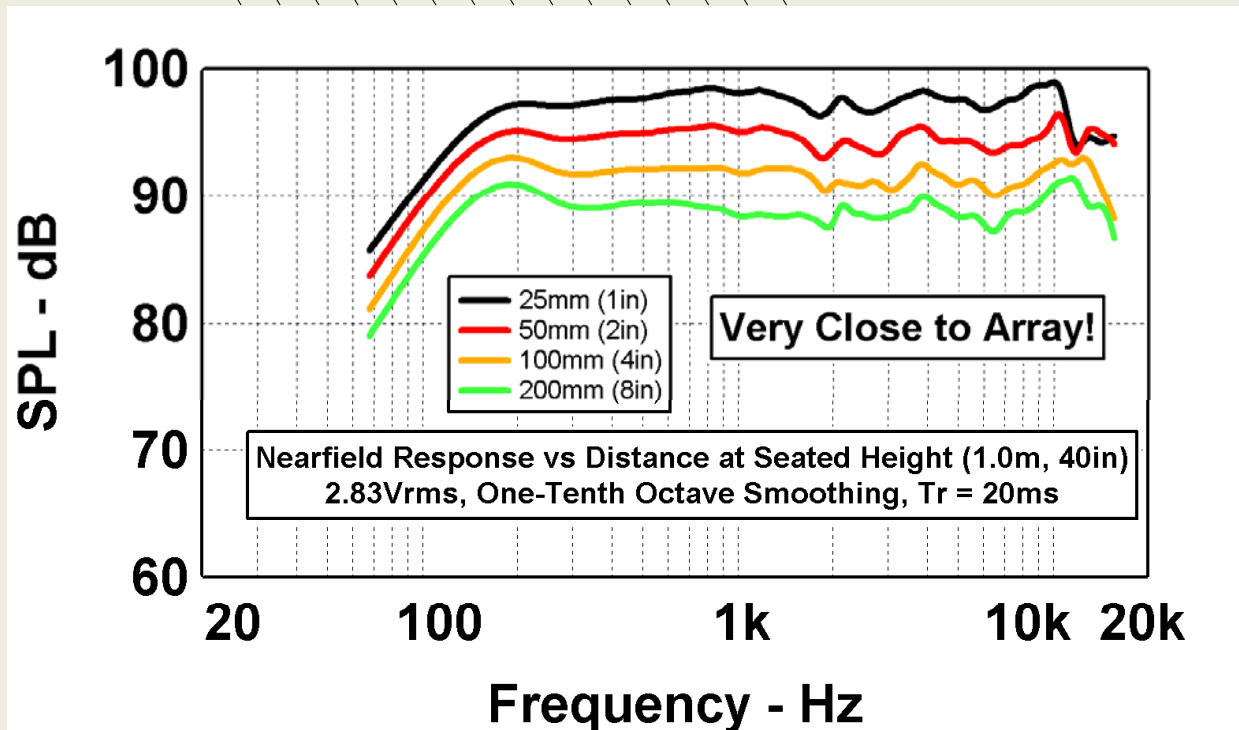

Implementation Using Systems



Real World Gear: The Latest Mini Line Arrays



Void Acoustics Arcline 6



TOA Electronics HX-5



Tecnore MiniArray



Proel Group AXIOM AX2265P



Outline Mini-COMPASS



Meyer Sound M1D



Martin Audio OmniLine



Ljud Design Scandinavia LDS CL-100



L-Acoustics KIVA

Implementation Using Systems



Real World Gear: The Latest Mini Line Arrays



EM Acoustics HALO



Duran Audio AXYS Target U16



EAW NTL 720 ("B.L.A.M.")



D.A.S. Audio Variant 25A



d&b audiotechnik T10



Coda Audio LA5A



Biema LAVA System



Alcons Audio LR7

Implementation Using Systems



1/14/2010

Keele - CBT Boston Presentation

109

A Killer CBT Ground-Plane System I designed Using 18 Each JBL VT4886 & 12 Each VT4883 Systems Drawing Using SketchUp. An 18° circular arc with an above-ground vertical beamwidth of 13.5°.

This system should be an absolute killer!!! 36 ea compression drivers, 72 ea 2.5" mids, 36 ea 6.5" LFs, and 24 ea 12" subs. 13,500 Watts HF, 19,200 Watts LF, 1,446 Lbs!!!!

But wait there's more....., double all these numbers for ground plane operation: 72 ea compression drivers, 144 ea 2.5" mids, 72 ea 6.5" LFs, and 48 ea 12" subs!!

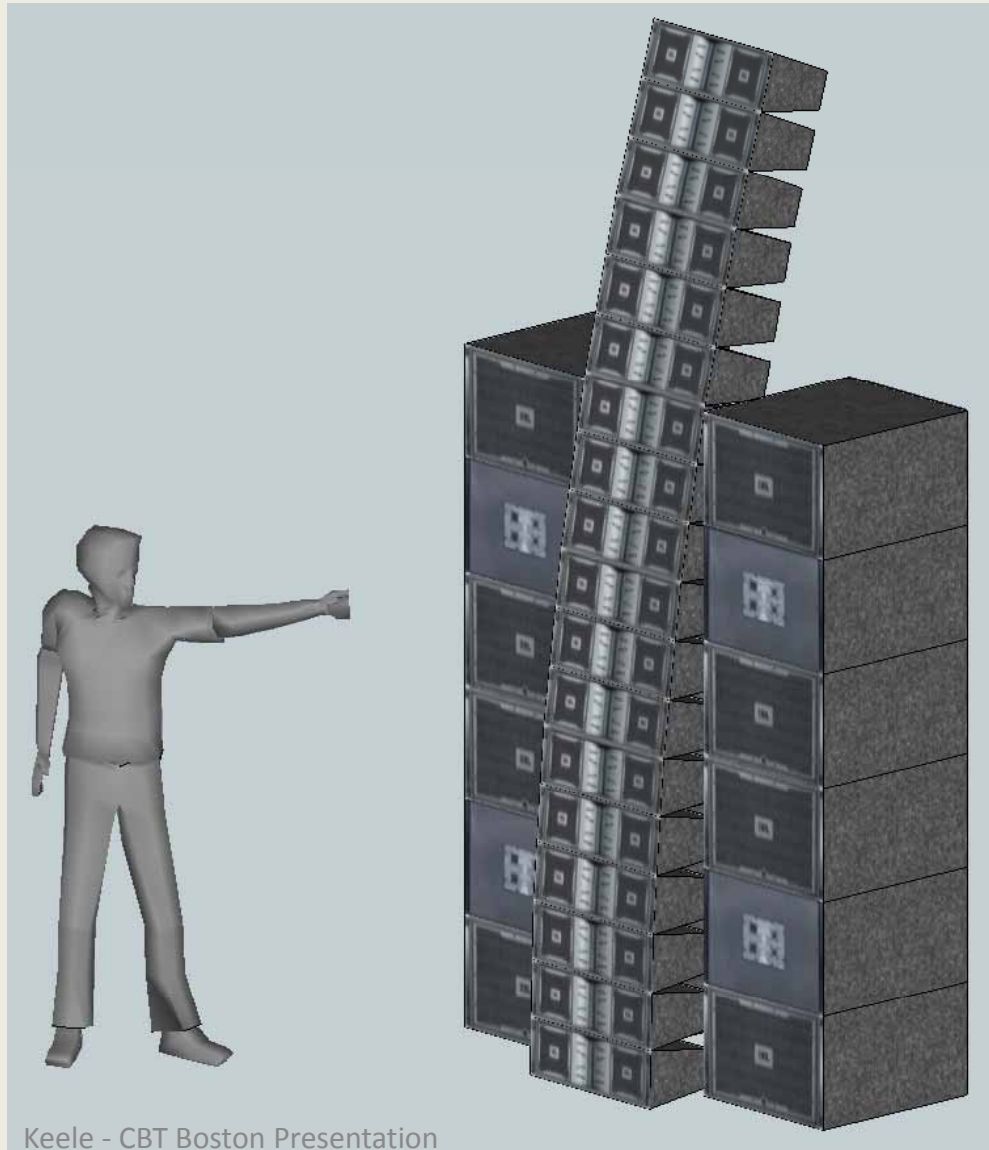

Application of CBT arrays in Sound Reinforcement:

A promotional banner for JBL Professional's CBT Series speakers. The banner features a dark background with a grid of red seats on the right side. On the left, there are three large, black, vertical line array column loudspeakers. The central one is shown from a side profile, revealing its internal speaker drivers. To the right of the speakers, the text 'CBT SERIES' is prominently displayed in a large, white, sans-serif font. Below it, in a smaller font, is 'CONSTANT BEAMWIDTH TECHNOLOGY™'. Further down, the text reads 'Line Array Column Loudspeakers' and 'Featuring JBL's Patent-Pending CONSTANT BEAMWIDTH TECHNOLOGY'. At the bottom right, the heading 'New CBT Systems:' is followed by a list of three models: 'CBT 50LA', 'CBT 100LA', and 'CBT 70J'. The JBL Professional logo is in the top left corner, and a navigation menu is at the top.

Application of CBT arrays in Sound Reinforcement:

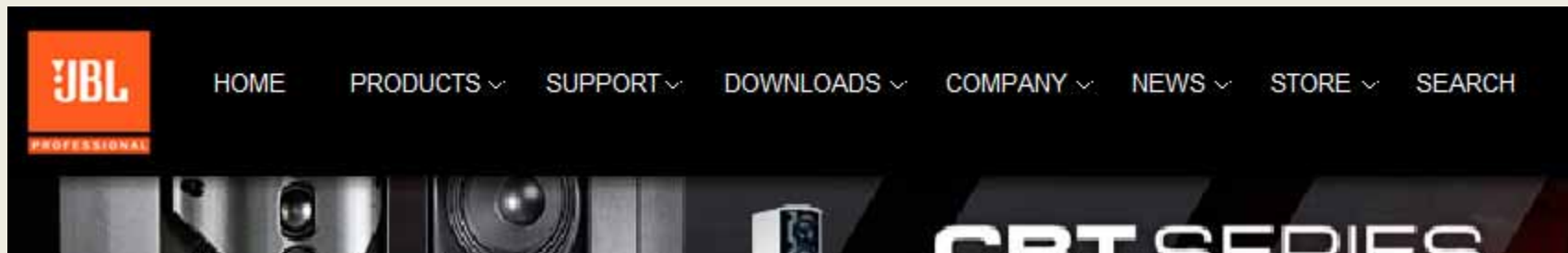

Remember that these JBL systems are the topic of two pending Harman patents which will issue soon!



Application of CBT arrays in Sound Reinforcement:

- (Aug. 28, 2008) I received e-mail and photos from **Marshall Kay** concerning large 12 ft tall CBT arrays that they constructed and installed in a large church in North Carolina.
- Kay is founder and president of loudspeaker manufacturer Audio Artistry. Siegfried Linkwitz works for them and is responsible for their current speaker line. Here is their “Beethoven” system ----- → →



CBT Arrays Installed in Marshall Kay's large 1200 seat North Carolina Church in a LCR configuration

(56 Four inch midrange drivers and 22 Ribbon Drivers)



1/14/2010

Keele - CBT Boston Presentation

114

CBT Array Installed in North Carolina Church Cont.:



1/14/2010

Keele - CBT Boston Presentation

115

CBT Array Installed in North Carolina Church Cont.:



1/14/2010

Keele - CBT Boston Presentation

116

CBT Array Installed in North Carolina Church

Cont.:



Three Half-Height Stage Monitors



1/14/2010

Keele - CBT Boston Presentation

118

Three Half-Height Stage Monitors



1/14/2010

Keele - CBT Boston Presentation

119

Three Half-Height Stage Monitors



CBT Array Installed in North Carolina Church Cont.: Comments from Kay's E-mail:

- Kay comment: “Coverage is quite uniform over most of the seating area and we have had overwhelming positive responses about the sound quality. I am amazed at how quickly the level drops as you pass by the -6dB point and this required us to carefully tweak the aiming of the arrays to keep from missing seats in the front of the church.”

Comments Concerning Listening Outside the Room

- Keele comments: “I was quite interested in your phone comment that when you step out the door of the church and hear the PA bleed through, the sound is well balanced and natural sounding and not like the typical sound system that sounds very muffled, bass heavy, and unintelligible. I attribute this completely to the constant directivity/beamwidth characteristics of the CBT array that energize the room with a flat sound power spectrum. It’s this characteristic of the CBT arrays that allows them to sound good even when listening behind a physical barrier that blocks the direct sound (see comment 3 in the next-to-the-last e-mail in this chain).
- Kay comments: “Having worked with Siegfried Linkwitz on dipoles, the out of the room test is one I always check and I was happy to find that the balance was amazingly good. I think this approach to directivity control, that Don has describe so well in his papers, will help a lot of problematic acoustic situations. Hopefully, we will see it become available in a commercial offering available to all.”

Recent Addition by Monte Kay to his Home Theater!

(Brother of Marshall Kay,
<http://www.mfk-projects.com/>)



Monte Kay's CBT Center Channel

(120° Circular-Arc CBT Array, 7 ft Wide)

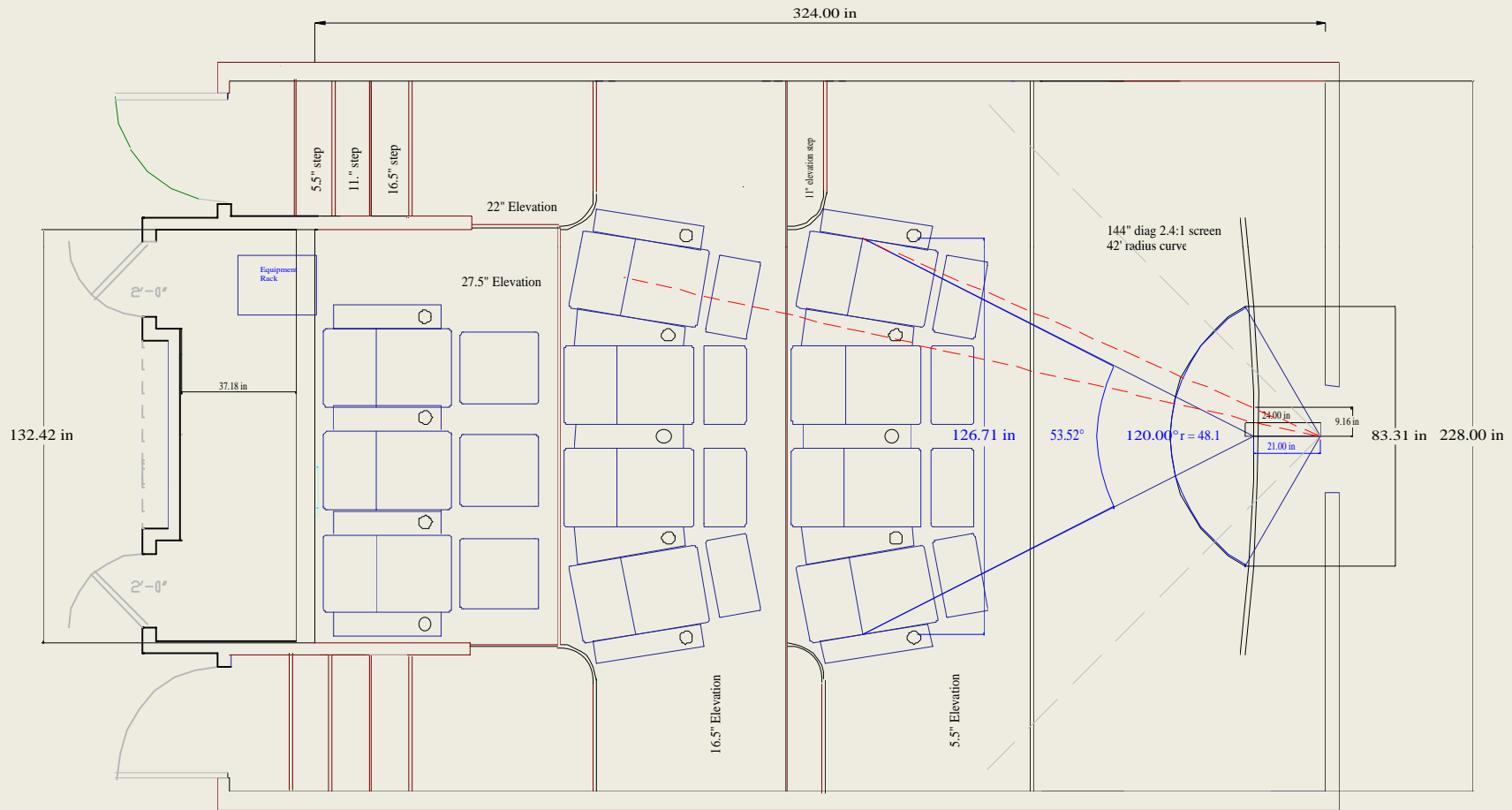

Monte Kay's CBT Center Channel

Uses 132 each
Tang Band tweeters
(0.77" Dia. Small!!):



Tang Band 13-17615 1/2" Silk Dome Tweeter Pair

Deal Price: \$12.94 (2) Save 30% Special Price: \$9.06 ea Qty: 2 (30-94) In Stock

FREE SHIPPING (containing 2 items)

FREE LOCAL PICKUP (containing 2 items)

Specifications: Material: Plastic / Mounting: None

Dimensions: A: 6.77" B: 6.77" C: 6.71"

TW SERIES 13-1761S

3.5cm TWEETER

- VERY BULKY AND HEAVY 3.5cm TWEETER, THE GO TO FOR LOW END ATX PC CASES AT LOW COST
- HIGH QUALITY OF FABRIC CONSTRUCTION
- HIGH PERFORMANCE FERRITE FLUID COOLED HOUSING

PARAMETER	VALUE
DIAPHRAGM MAT.	Paper
RESONANCE FREQ.	9.5
NOMINAL IMPEDANCE	8Ω
DCR IMPEDANCE	7Ω
SENSITIVITY 1W/1M	89 dB
FREQUENCY RESPONSE	100Hz-10K Hz
FREE AIR RESONANCE	400Hz
VOICE COIL DIAMETER	18.20mm
AGE CAPACITANCE	1.5µm
ANTI-DAMPENING	1.10
MAXIMUM POWER INPUT	30W
FORCE FACTOR, BL	6A
IMPEDANCE WEIGHT (1/2W)	Weightless
MOVING MASS	6A
PERMANENT DEFORMATION	0%
SUSPENSION COMPLIANCE	6A
EFFECTIVE RADIATING AREA	6A
Qms	6A
Qms	6A
Qms	6A
Qms	6A
Qms	6A
Qms	6A
Qms	6A
Qms	6A

TB SPEAKERS

Monte Kay's CBT Center Channel



1/14/2010

Keele - CBT Boston Presentation

127

Monte Kay's CBT Center Channel



1/14/2010

Keele - CBT Boston Presentation

128

Monte Kay's CBT Center Channel



1/14/2010

Keele - CBT Boston Presentation

129

Monte Kay's CBT Center Channel

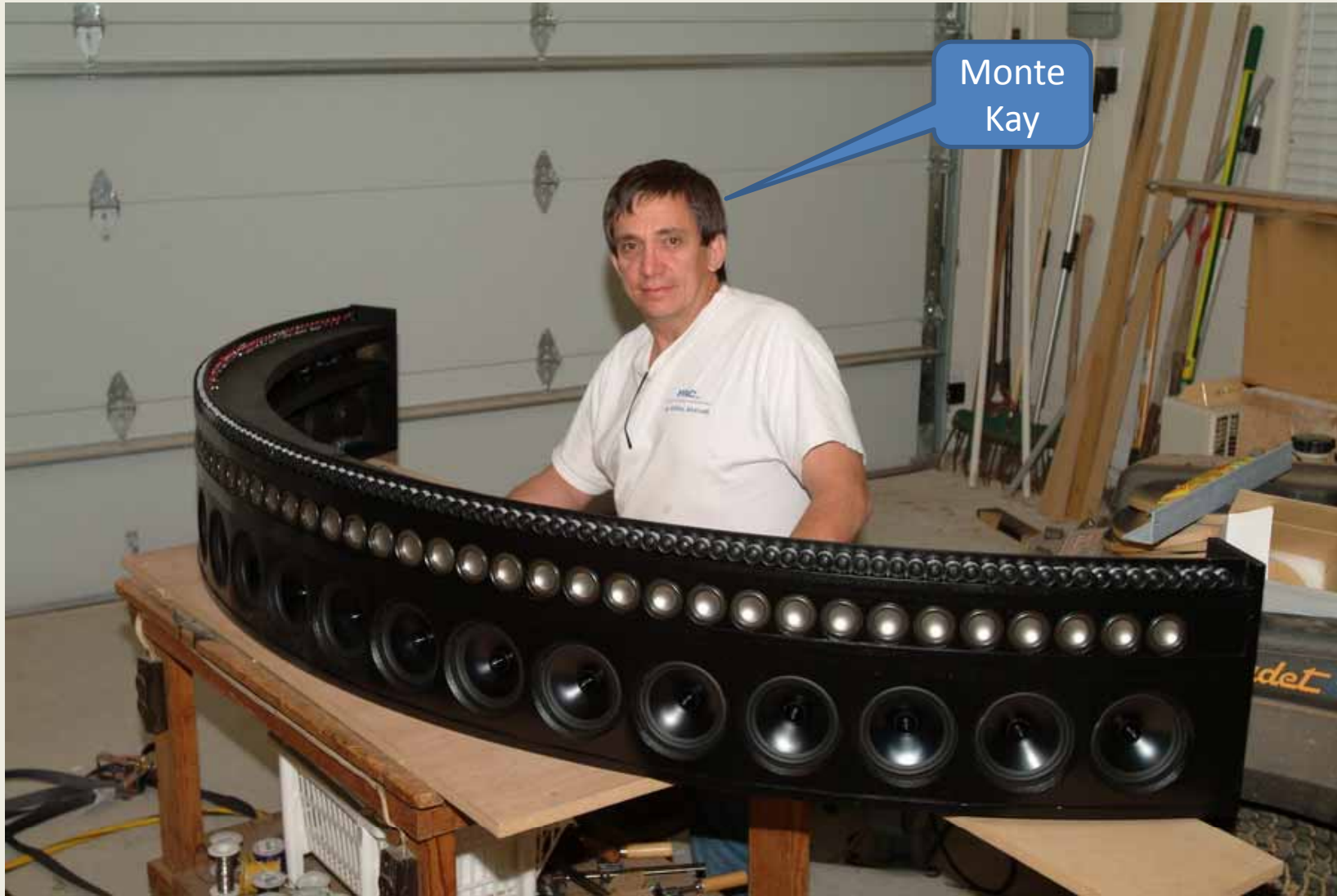

Monte Kay's CBT Center Channel



1/14/2010

Keele - CBT Boston Presentation

131

Use of Ground-Plane CBT Line Arrays for Sound Reinforcement

Band Sound Reinforcement at Presidio Park, San Francisco, CA for
“Bridge to Bridge” 12K Run, Sunday Oct. 5th, 2008



Use of Ground-Plane CBT Line Arrays for Sound Reinforcement: Cont.

- **Wide-angle broad-band ground-plane CBT line arrays offer a very viable, high performance, simple, and thrifty alternative to the usual reinforcement setup, particularly when the main speakers can't be hung overhead. The usual arrangement consists of a pair of directional ground-mounted main systems located on either side of the stage coupled with stage monitors on the stage as outlined in the previous description.**
- **A single or double set of ground-plane CBT arrays located on stage behind the performers can substitute for both mains and stage monitors. Thus located, the CBT array offers a number of very strong advantages:**
 1. **Exceptionally Even Coverage:**

The inherent broad-band constant bandwidth/directivity design of the CBT arrays provides extremely even coverage at all locations: right-left, up-down, and near-far. This includes points on and near the floor, points above the array, and points in the extreme nearfield only inches from the front surface of the array. Because the array is specifically designed to operate over a reflective ground plane, it does not suffer from destructive floor reflections that cause comb filtering effects.
 2. **Flat Energy Response:**

The system's broad-band constant directivity means that its radiated power is unvarying with frequency. With constant radiated power the system sounds equally well balanced in the direct field or in the reverberant field, and even behind obstructions that block the direct sound.
 3. **Less Front-Back Variation in Sound Level:**

The CBT array's sound level falls only 3 dB for each doubling of distance for a significant distance in front of the array. This means that a CBT array can supply much higher levels in the back of venue for the same levels in front as compared to a typical sound reinforcement two-way woofer-horn speaker system. This also means that if a CBT array is set up to supply the same levels in the rear of the audience as a typical reinforcement speaker, the levels in the front of the audience area and on stage will be significantly lower. (See the following graphs.)

Use of Ground-Plane CBT Line Arrays for Sound Reinforcement: Cont.

4. **Improved Articulation and Intelligibility at all Listening Points:**

This is a direct result of the constant beamwidth/directivity and the absence of polar lobes of the CBT array. Destructive side wall reflections are minimized because the room's side walls are illuminated with flat sound energy.

5. **No Stage Monitors:**

With the CBT arrays mounted behind the performers, the performers hear the same sound that the audience hears. Practically, this works only because a CBT line array's sound level on stage is much lower than typical sound reinforcement speakers for the same level in the audience area.

6. **No Interference with Audience Sight Lines:**

This is a direct result of the capability of CBT arrays to operate behind the performers. Large and bulky systems mounted to the right and left of stage front are not required!

7. **Less Prone to Feedback Problems and More Performer Freedom to Move Around on the Stage:**

This is another direct result of the constant beamwidth/directivity and the absence of frequency-dependent polar lobes of the CBT array. With these characteristics, the feedback threshold is essentially independent of position which means that once the howl-back level is set at a particular location, the system will not be prone to go into feedback at other locations.

Use of Ground-Plane CBT Line Arrays for Sound Reinforcement : Cont.

8. **No Voicing or On-Site Equalization Adjustments Required:**

Voicing and equalization is only a requirement for speaker systems that are not constant directivity and beamwidth and that may exhibit frequency-dependent lobes. The CBT crossover and equalization is set at design time and requires essentially no adjustments in the field. The only choices that must be made in the field are the CBT's coverage angle (directly dependent on the CBT's arc angle: $\text{Beamwidth} = 0.75 \times \text{ArcAngle}$) and its aiming.

9. **A Much Simpler System:**

- a. Fewer speakers
- b. Fewer power amps
- c. Fewer processing channels
- d. Minimal on-site voicing, equalization, and adjustment.

This is a direct result of the elimination of the stage monitors and the simpler curved-arc CBT design that requires no DSP processing. The constant directivity/beamwidth nature of the CBT array minimizes the need for on-site EQ and adjustment. Set it up and forget it!

SPL vs. Distance

- The following two graphs show the simulated sound pressure level versus distance comparing a point source to a 3m-high 20-deg-arc ground-plane CBT line array providing a 15 deg above-ground beamwidth. This CBT array would be an appropriate design for the previously mentioned band application. The point source rolls off at 6 dB per doubling of distance for all distances. However, the CBT array rolls at only half this rate at 3 dB per doubling of distance over a significant range of about 1 ft to 100 ft in front of the array. However, at distances beyond 100 ft, this CBT line array also rolls off at 6 dB per doubling of distance. In contrast to an equally-driven straight-line array, the distance rolloff of a CBT line array is essentially independent of frequency.
- The gradual 3 dB per doubling of distance rolloff of the CBT array is a great advantage in many sound reinforcement situations. It means that the CBT array's roll off with distance is much less rapid than the roll off of a typical two-way reinforcement system composed of a 15" woofer with HF horn. When the typical two-way system is turned up loud enough to provide adequate level to the rear of the audience area, it is very loud at listening points near the front of the audience area and particularly loud directly in front of the speaker. The CBT array does not suffer from these problems.
- The advantages of the gradual 3 dB roll off of the CBT array are illustrated in the following two graphs. The first graph illustrates that for equal sound levels up front, the CBT array can provide much higher levels in the rear of the audience, sometimes as much as 20 dB! Alternately, the second graph shows that for the same loudness in the rear of the audience area, the CBT array can be significantly less loud up front, sometimes as much as 20 dB.

SPL vs. Distance

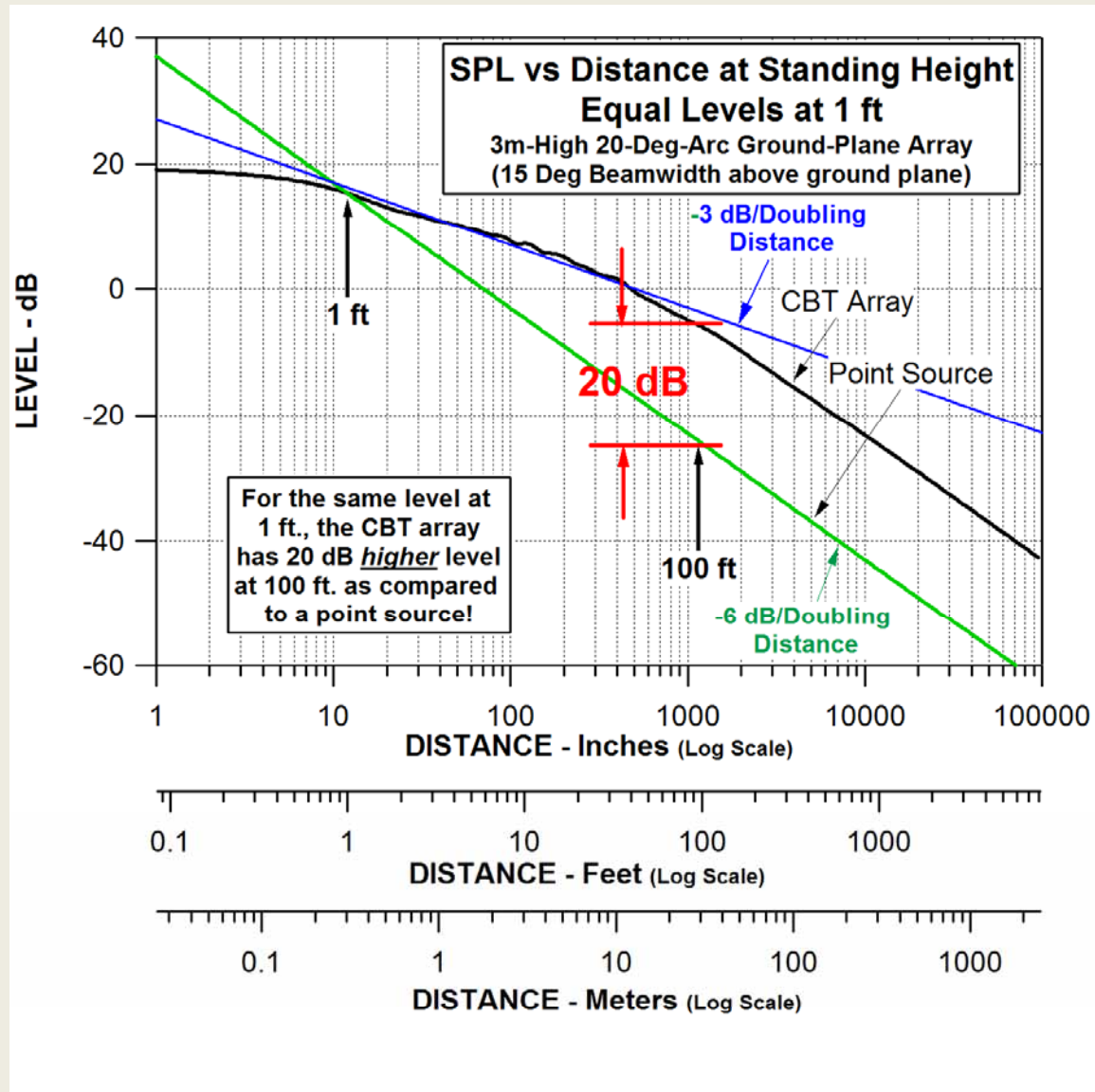

SPL vs. Distance

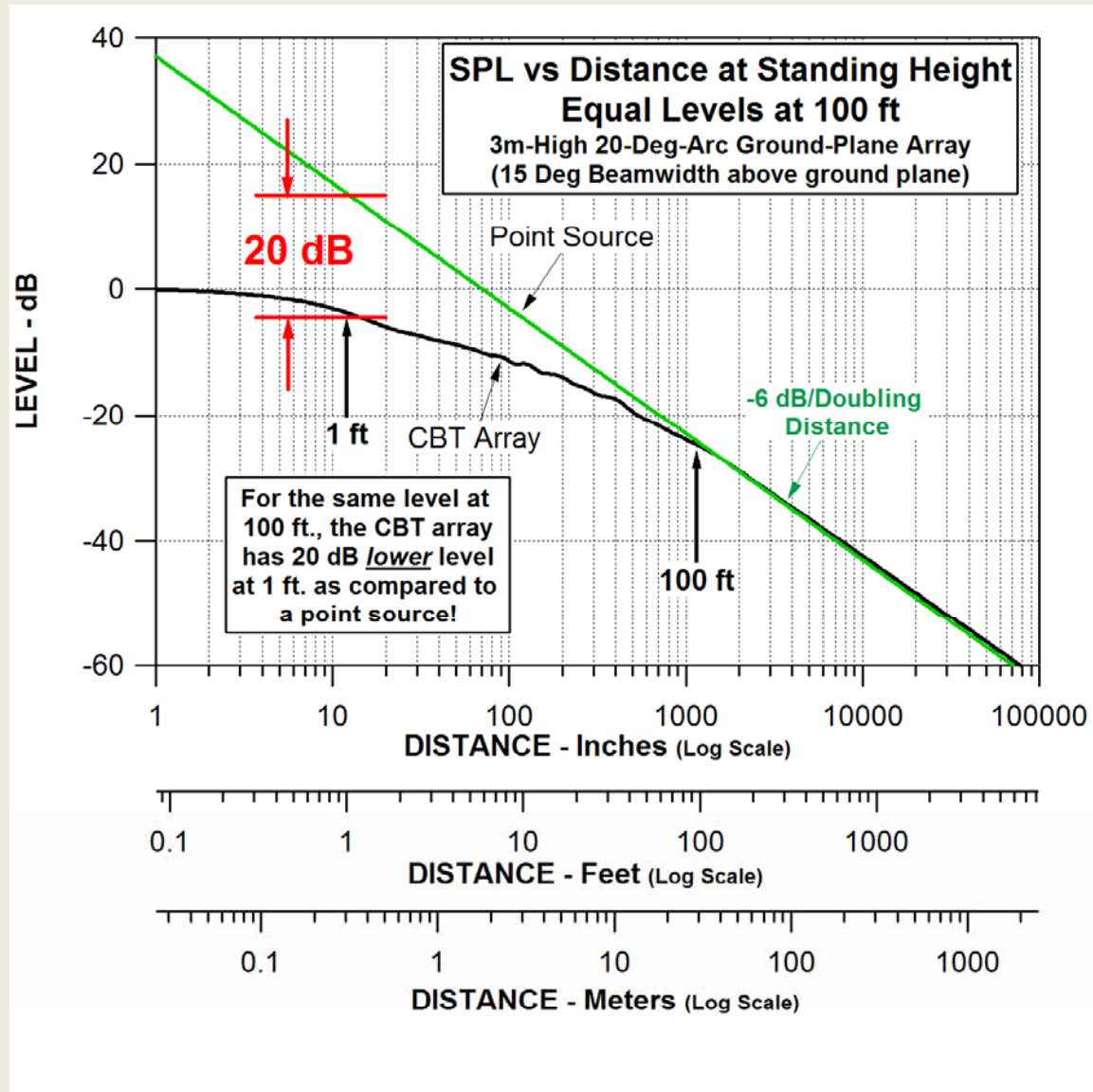

An Excellent Book!

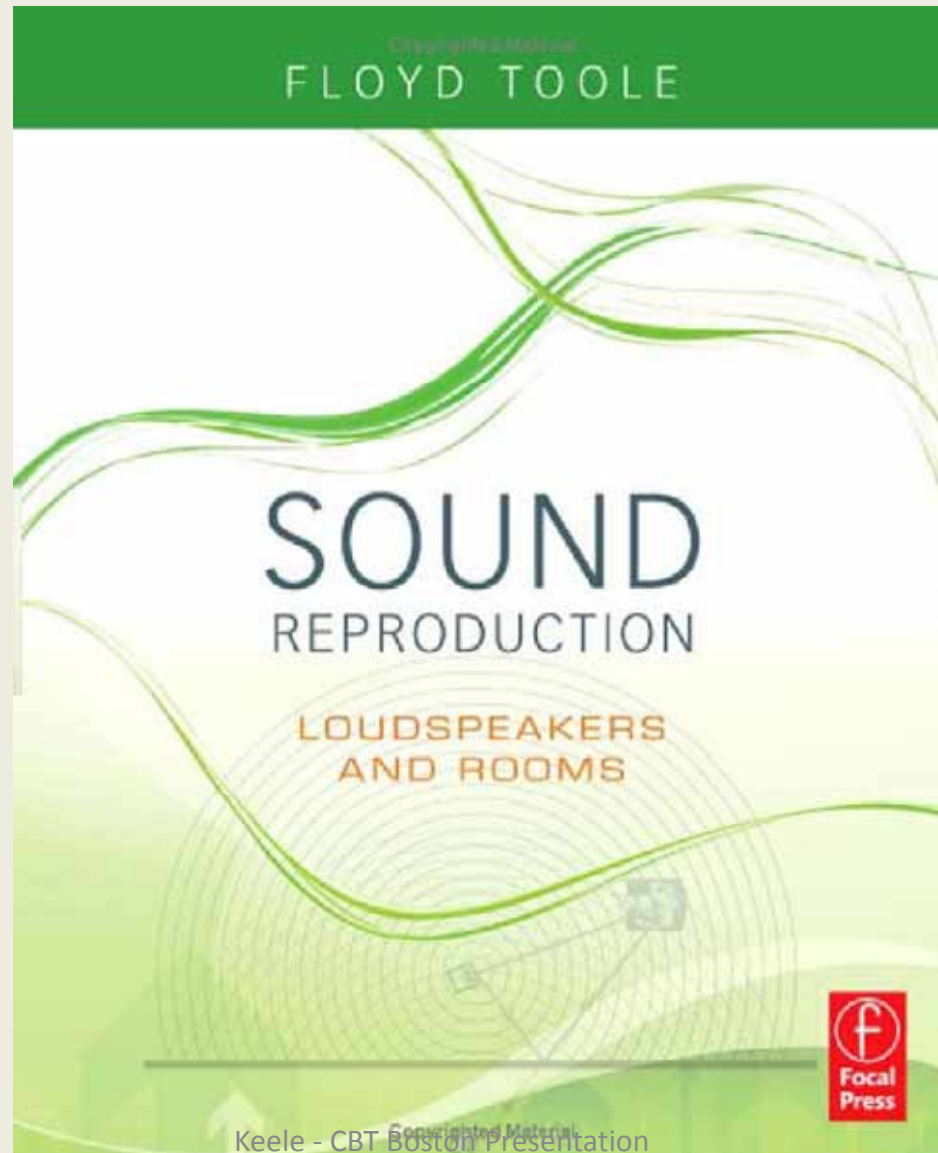

Sound-Fields generated above a ground plane by several sources.

(Page Images Courtesy Focal Press)

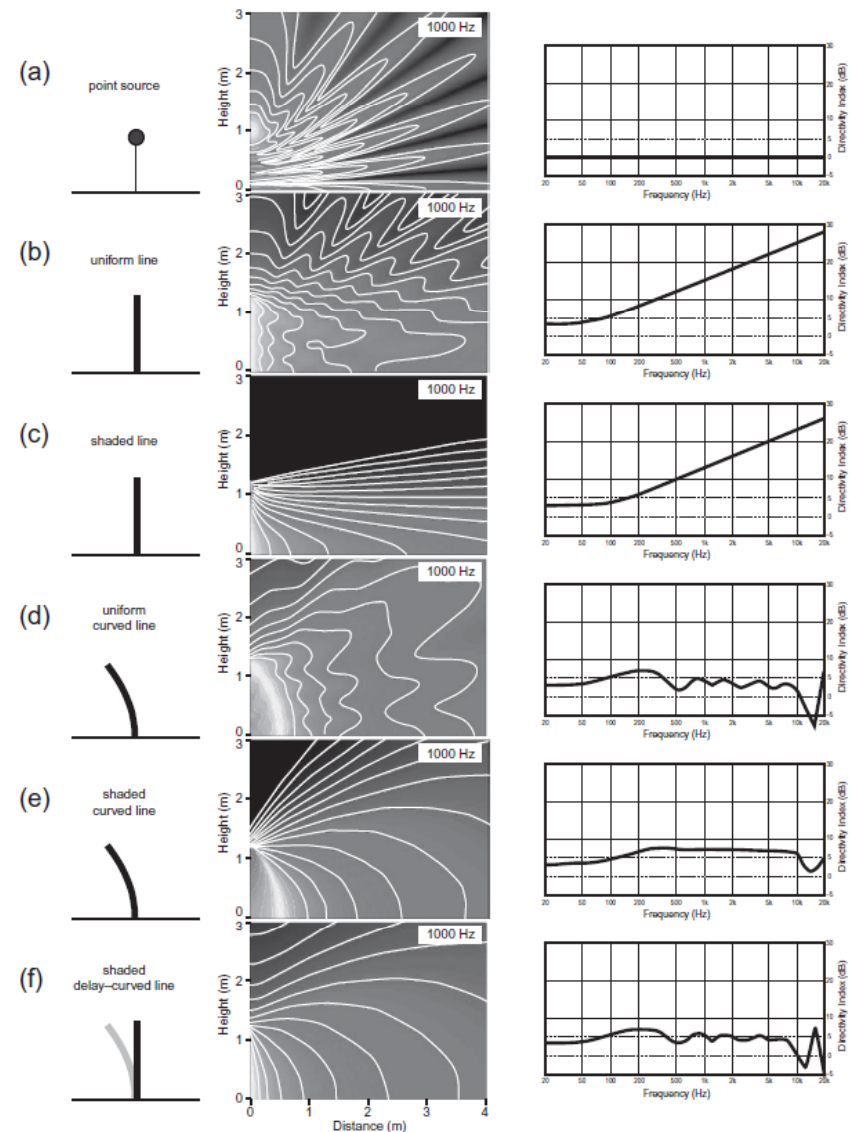

FIGURE 18.3 Illustrations of the near-sound fields generated above a ground plane by several sound sources. The shading gets darker as sound levels drop; adjacent contour lines represent sound levels that differ by 3 dB. The original paper displays results for several frequencies; all of those shown are for 1 kHz. The words and graphics on the left explain the sources. On the right are far-field directivity indexes. Data from Keele and Button (2005).

The Perfect Surround Speaker?

(Page Images Courtesy Focal Press)

FIGURE 18.21

Data from Keele and Button (2005) showing a constant beamwidth transducer (CBT) inverted to simulate a surround loudspeaker, showing sound levels as they might be at several listening locations. This simplistic illustration ignores the fact that in reality there is a wall behind the loudspeaker, which was not part of the Keele and Button simulations. A real loudspeaker for this application would need to be modified to accommodate this constraint. The white lines are contours of equal sound level and adjacent lines differ by 3 dB.

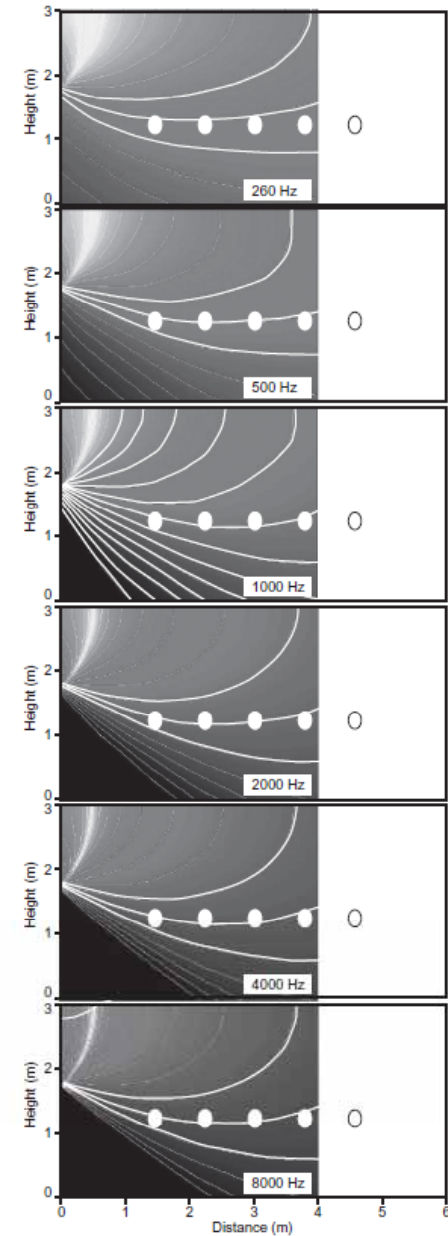

CBT Ground-Plane Array Upside Down on the Ceiling

(16° Circular-Arc Array, 12° Beamwidth, 11.5 ft high)

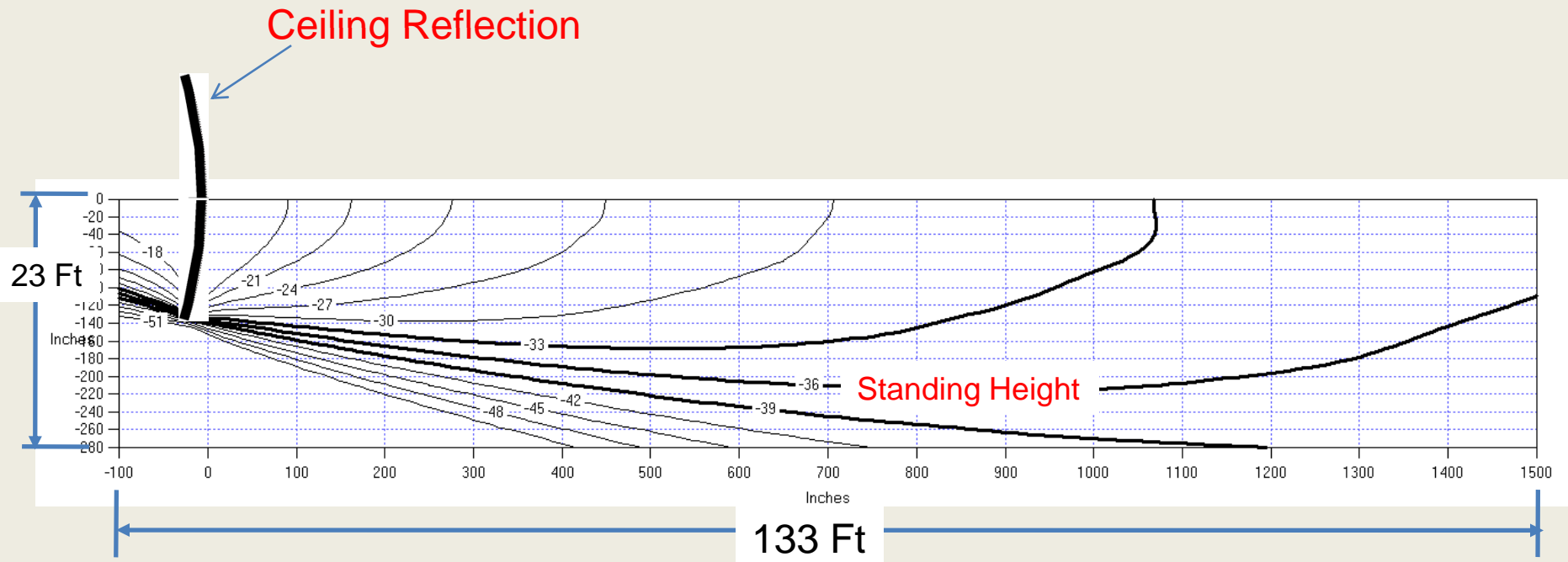

Enough Already!
The End